

# JVC



## COMPACT COMPONENT SYSTEM

# DX-J21

— Consists of CA-DXJ21, SP-DXJ21F, and SP-DXJ21W

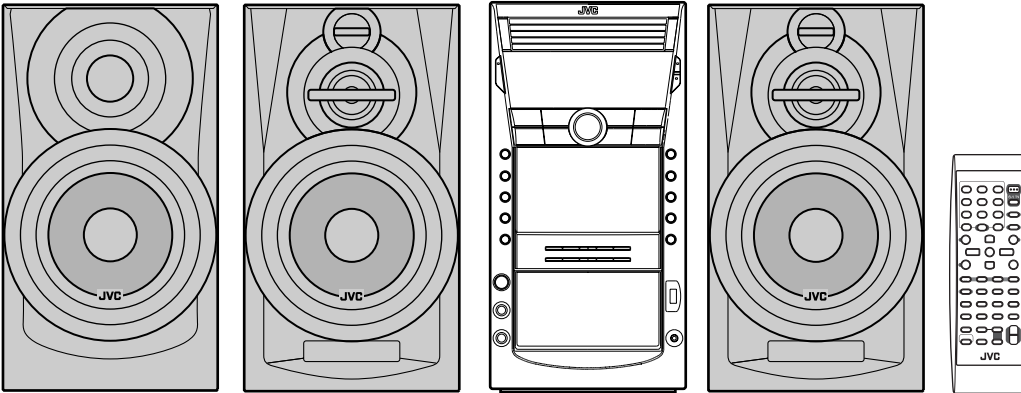

MP3/WMA/WAV



### For Customer Use:

Enter below the Model No. and Serial No. which are located either on the rear, bottom or side of the cabinet. Retain this information for future reference.



Model No. \_\_\_\_\_

Serial No. \_\_\_\_\_

## INSTRUCTIONS

# Warnings, Cautions and Others

## Mises en garde, précautions et indications diverses

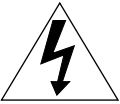

	<b>CAUTION</b> RISK OF ELECTRIC SHOCK DO NOT OPEN	
<b>CAUTION:</b> TO REDUCE THE RISK OF ELECTRIC SHOCK, DO NOT REMOVE COVER (OR BACK). NO USER SERVICEABLE PARTS INSIDE. REFER SERVICING TO QUALIFIED SERVICE PERSONNEL.		



The lightning flash with arrowhead symbol, within an equilateral triangle is intended to alert the user to the presence of uninsulated "dangerous voltage" within the product's enclosure that may be of sufficient magnitude to constitute a risk of electric shock to persons.



The exclamation point within an equilateral triangle is intended to alert the user to the presence of important operating and maintenance (servicing) instructions in the literature accompanying the appliance.

	<b>ATTENTION</b> RISQUE D'ÉLECTROCUTION NE PAS OUVRIR	
<b>ATTENTION:</b> POUR ÉVITER TOUT RISQUE D'ÉLECTROCUTION, NE PAS OUVRIR LE BOÎTIER. AUCUNE PIÈCE INTÉRIEURE N'EST À RÉGLER PAR L'UTILISATEUR. SE RÉFÉRER À UN AGENT QUALIFIÉ EN CAS DE PROBLÈME.		

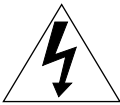

Le symbole de l'éclair à l'intérieur d'un triangle équilatéral est destiné à alerter l'utilisateur sur la présence d'une "tension dangereuse" non isolée dans le boîtier du produit. Cette tension est suffisante pour provoquer l'électrocution de personnes.



Le point d'exclamation à l'intérieur d'un triangle équilatéral est destiné à alerter l'utilisateur sur la présence d'opérations d'entretien importantes au sujet desquelles des renseignements se trouvent dans le manuel d'instructions.

**WARNING:**  
TO PREVENT FIRE OR SHOCK HAZARDS, DO NOT EXPOSE THIS APPARATUS TO RAIN OR MOISTURE.

**AVERTISSEMENT:**  
POUR PRÉVENIR LES RISQUES D'INCENDIE OU DE CHOCS ÉLECTRIQUES, NE PAS EXPOSER CE APPAREIL À LA PLUIE OU À L'HUMIDITÉ.

### For U.S.A.

**Caution:** Changes or modifications not expressly approved by party responsible for compliance could void the user's authority to operate the equipment.

**Note:** This equipment has been tested and found to comply with the limits for a Class B digital device, pursuant to Part 15 of the FCC Rules. These limits are designed to provide reasonable protection against harmful interference in a residential installation. This equipment generates, uses and can radiate radio frequency energy and, if not installed and used in accordance with the instructions, may cause harmful interference to radio communications. However, there is no guarantee that interference will not occur in a particular installation. If this equipment does cause harmful interference to radio or television reception, which can be determined by turning the equipment off and on, the user is encouraged to try to correct the interference by one or more of the following measures:

- Reorient or relocate the receiving antenna.
- Increase the separation between the equipment and receiver.
- Connect the equipment into an outlet on a circuit different from that to which the receiver is connected.
- Consult the dealer or an experienced radio/TV technician for help.

### Pour les Etats-Unis

**Attention:** Les changements ou les modifications qui ne sont pas explicitement approuvés par la partie responsable de l'observance pourraient mettre fin au droit de l'utilisateur d'utiliser le matériel.

**Remarque:** Cet appareil a été testé et il s'est avéré conforme aux limites applicables à un appareil numérique de classe B, en vertu de la Partie 15 des Règles de la FCC. Ces limites sont conçues de manière à assurer une protection raisonnable contre les interférences nuisibles dans une installation résidentielle.

Cet appareil produit, utilise et peut émettre une énergie de haute fréquence et, s'il n'est pas installé et utilisé en conformité avec les instructions, il peut causer des interférences nuisibles aux communications radio. Il n'y a, toutefois, aucune garantie que des interférences ne se produiront pas dans une installation particulière. Si cet appareil cause effectivement des interférences nuisibles à la réception de la radio ou de la télévision, ce qu'on peut établir en mettant l'appareil en marche et à l'arrêt, nous encourageons l'utilisateur à tenter de corriger l'interférence par une ou plusieurs des mesures suivantes:

- réorienter ou déplacer l'antenne de réception;
- accroître la séparation entre l'appareil et le récepteur;
- brancher l'appareil dans une prise ou un circuit autre que celui auquel le récepteur est branché;
- consulter un vendeur ou un technicien radio/TV expérimenté pour obtenir de l'aide.

### For Canada/pour le Canada

THIS DIGITAL APPARATUS DOES NOT EXCEED THE CLASS B LIMITS FOR RADIO NOISE EMISSIONS FROM DIGITAL APPARATUS AS SET OUT IN THE INTERFERENCE-CAUSING EQUIPMENT STANDARD ENTITLED "DIGITAL APPARATUS," ICES-003 OF THE DEPARTMENT OF COMMUNICATIONS.

CET APPAREIL NUMERIQUE RESPECTE LES LIMITES DE BRUITS RADIOELECTRIQUES APPLICABLES AUX APPAREILS NUMIRIQUES DE CLASSE B PRESCRITES DANS LA NORME SUR LE MATERIEL BROUILLEUR: "APPAREILS NUMERIQUES", NMB-003 EDICTEE PAR LE MINISTRE DES COMMUNICATIONS.

### CAUTION

To reduce the risk of electrical shocks, fire, etc.:

1. Do not remove screws, covers or cabinet.
2. Do not expose this appliance to rain or moisture.

### ATTENTION

Afin d'éviter tout risque d'électrocution, d'incendie, etc.:

1. Ne pas enlever les vis ni les panneaux et ne pas ouvrir le coffret de l'appareil.
2. Ne pas exposer l'appareil à la pluie ni à l'humidité.

### CAUTION

The  $\text{O/I}$  button in any position does not disconnect the mains line.

Disconnect the mains plug to shut the power off completely (the STANDBY lamp goes off).

The MAINS plug or an appliance coupler is used as the disconnect device, the disconnect device shall remain readily operable.

- When the system is on standby, the STANDBY lamp lights red.
- When the system is turned on, the STANDBY lamp goes off.

The power can be remote controlled.

### ATTENTION

La touche  $\text{O/I}$ , dans n'importe quelle position, ne déconnecte pas le système du secteur.

Déconnectez la fiche de secteur pour mettre l'appareil complètement hors tension (le témoin STANDBY s'éteint).

La fiche secteur ou un coupleur est utilisé comme dispositif de déconnexion de l'appareil, et l'appareil déconnecté doit être prêt à être utilisé.

- Quand le système est en attente, le témoin STANDBY est allumé en rouge.
- Quand le système est sous tension, le témoin STANDBY s'éteint.

L'alimentation peut être télécommandée.

### CAUTION:

Excessive sound pressure from earphones or headphones can cause hearing loss.

### ATTENTION:

Une pression acoustique excessive des écouteurs ou du casque d'écoute peut entraîner une perte auditive.

### IMPORTANT FOR LASER PRODUCTS

1. CLASS 1 LASER PRODUCT
2. **CAUTION:** Do not open the top cover or cabinet. There are no user serviceable parts inside the unit; leave all servicing to qualified service personnel.
3. **CAUTION:** Visible and/or invisible class 1M laser radiation when open. Do not view directly with optical instruments.
4. REPRODUCTION OF LABEL: CAUTION LABEL, PLACED INSIDE THE UNIT.

### IMPORTANT POUR PRODUITS LASER

1. PRODUIT LASER CLASSE 1
2. **ATTENTION:** N'ouvrez pas le couvercle supérieur ni le coffret de l'appareil. Il n'y a aucune pièce réparable par l'utilisateur à l'intérieur de l'appareil; confiez toute réparation à un personnel qualifié.
3. **ATTENTION:** Rayonnement laser visible et/ou invisible de classe 1M une fois ouvert. Ne pas regarder directement avec des instruments optiques.
4. REPRODUCTION DE L'ÉTIQUETTE: ÉTIQUETTE DE PRÉCAUTION PLACÉE À L'INTERIEUR DE L'APPAREIL.

<b>CAUTION</b> VISIBLE AND/OR INVISIBLE CLASS 1M LASER RADIATION WHEN OPEN. DO NOT VIEW DIRECTLY WITH OPTICAL INSTRUMENTS. IEC60825-1:2001 (ENG)	<b>ATTENTION</b> RAYONNEMENT LASER VISIBLE ET/OU INVISIBLE DE CLASSE 1M UNE FOIS OUVERT. NE PAS REGARDER DIRECTEMENT AVEC DES INSTRUMENTS OPTIQUES. (FRA)	<b>AVISO</b> RADIACION LASER DE CLASE 1M VISIBLE Y/O INVISIBLE CUANDO ESTA ABIERTO. NO MIRAR DIRECTAMENTE CON INSTRUMENTAL OPTICO. (ESP)	<b>VARNING</b> SYNLIG OCH/ELLER OSYNLIG LASERSTRÅLNING, KLASS 1M, NÄR DENNA ÄR ÖPPNAD. BETRAKTA EJ STRÅLEN MED OPTISKA INSTRUMENT. (SWE)	<b>注意</b> この装置はレーザー 及び赤外線不可視 のクラス1M レーザー放射が 放射する。 光学装置で直接 見ないでください。 (JPN)	<b>CAUTION</b> VISIBLE AND/OR INVISIBLE CLASS 1 LASER RADIATION WHEN OPEN. DO NOT STARE INTO BEAM. FDA 21 CFR (ENG) LV4493-033A
--	--	---	---	---	---

**CAUTION!**

To avoid personal injury or accidentally dropping the unit, have two persons unpack, carry, and install the unit.

**ATTENTION!**

Pour éviter toute blessure personnelle ou toute chute accidentelle de l'appareil, celui-ci doit être déballé, transporté et installé par deux personnes.



23.2 kg/52 lbs

**CAUTION**

Battery shall not be exposed to excessive heat such as sunshine, fire or the like.

**ATTENTION**

Les piles ne doivent en aucun cas être exposées à une chaleur excessive (lumière du soleil, feu, etc.).



[European Union only]  
[Union européenne seulement]

**CAUTION:**

- Do not block the ventilation openings or holes. (If the ventilation openings or holes are blocked by a newspaper or cloth, etc., the heat may not be able to get out.)
- Do not place any naked flame sources, such as lighted candles, on the apparatus.
- When discarding batteries, environmental problems must be considered and local rules or laws governing the disposal of these batteries must be followed strictly.
- Do not expose this apparatus to rain, moisture, dripping or splashing and that no objects filled with liquids, such as vases, shall be placed on the apparatus.

**ATTENTION:**

- Ne bloquez pas les orifices ou les trous de ventilation. (Si les orifices ou les trous de ventilation sont bloqués par un journal un tissu, etc., la chaleur peut ne pas être évacuée correctement de l'appareil.)
- Ne placez aucune source de flamme nue, telle qu'une bougie, sur l'appareil.
- Lors de la mise au rebut des piles, veuillez prendre en considération les problèmes de l'environnement et suivre strictement les règles et les lois locales sur la mise au rebut des piles.
- N'exposez pas cet appareil à la pluie, à l'humidité, à un égouttement ou à des éclaboussures et ne placez pas des objets remplis de liquide, tels qu'un vase, sur l'appareil.

## Caution: Proper Ventilation

To avoid risk of electric shock and fire, and to prevent damage, locate the apparatus as follows:

1. Front: No obstructions and open spacing.
2. Sides/Top/Back: No obstructions should be placed in the areas shown by the dimensions below.
3. Bottom: Place on the level surface. Maintain an adequate air path for ventilation by placing on a stand with a height of 10 cm (3-15/16") or more.

## Attention: Aération correcte

Pour prévenir tout risque de décharge électrique ou d'incendie et éviter toute détérioration, installez l'appareil de la manière suivante:

1. Avant: Bien dégagé de tout objet.
2. Côtés/dessus/dessous: Assurez-vous que rien ne bloque les espaces indiqués sur le schéma ci-dessous.
3. Dessous: Posez l'appareil sur une surface plane et horizontale. Veillez à ce que sa ventilation correcte puisse se faire en le plaçant sur un support d'au moins dix centimètres de hauteur.

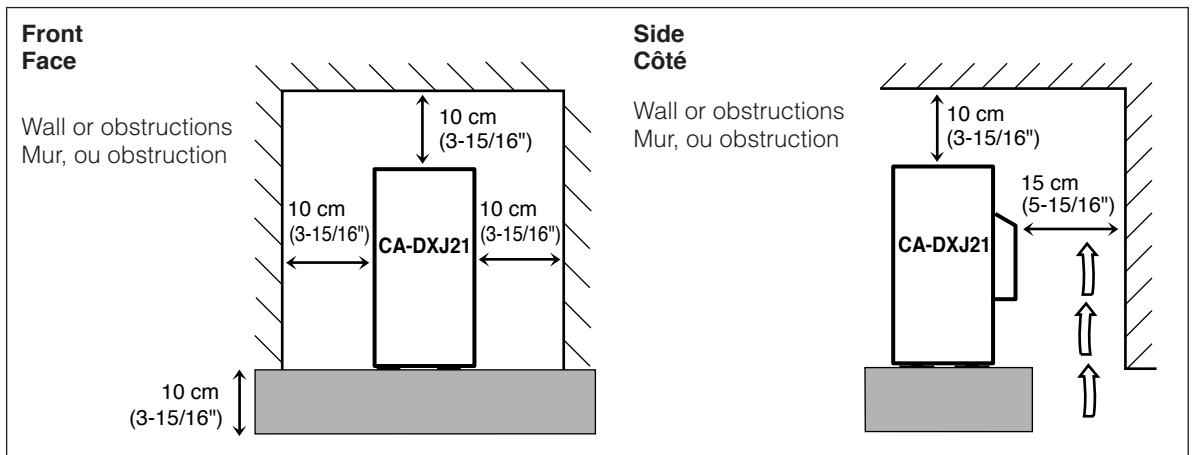

# Introduction

## Playable Disc/File Types

INFO



The “√” in the list below shows available disc/file types.

Recording format		Media type		
		CD-R/-RW*1	DVD-R/-RW, +R/+RW*2	USB mass storage class device
Discs	CD-DA (normal CD)	√	—	—
	VCD/SVCD	√	—	—
	DVD Video	—	√	—
	DVD-VR	—	√*3	—
AV files	Audio file: MP3/WMA/WAV	√	√	√
	Video file: MPEG-1/MPEG-2/ ASF	√	√	√
	Still picture file: JPEG	√	√	√

\*1 Recorded with “ISO 9660” format.

\*2 Recorded with “UDF-Bridge” format.

\*3 Not applicable for +R/+RW.

In addition to the above discs/files, this System can play back audio data recorded on CD-Extra and DVD/CD Text.

- The following discs cannot be played back: DVD-RAM, CD-I (CD-I Ready), Photo CD and CD-G (CD-Graphics).  
Playing back these discs will generate noise and damage the speakers.
- This System cannot play back DVD-VR disc with CPRM (Content Protection for Recordable Media).
- DVD Logo is a trademark of DVD Format/Logo Licensing Corporation.
- In this manual, “file” and “track” are interchangeably used for AV file operations.
- It is possible to play back finalized +R/+RW (DVD Video format only) discs.

### Caution for DualDisc playback:

The Non-DVD side of a “DualDisc” does not comply with the “Compact Disc Digital Audio” standard. Therefore, the use of Non-DVD side of a DualDisc on this product may not be recommended.

### About color system

This System accommodates both NTSC and PAL system and can play back discs/files recorded in either system. To change the color system, see page 6.

### Note on Region Code

DVD Video players and DVD Video discs have their own Region Code numbers. This system can play back DVD Video discs whose Region Code numbers include “1.”



### Audio formats

The System can play back the following digital audio formats.

- **LPCM** (Linear PCM), **DIGITAL** (Dolby Digital), **DTS** (Digital Theater Systems), **MPEG Audio**
- Multi-channel sound will be downmixed into 2-channels. To enjoy multi-channel sound, connect a compatible decoder or an amplifier with a compatible decoder to the OPTICAL DIGITAL OUTPUT terminal on the rear.

### How to Read This Manual

- Button and control operations are explained in the table below.
- Some related tips and notes are explained later in the sections “Learning More about This System” and “Troubleshooting,” but not in the same section explaining the operations (INFO indicates that the content has some information).

	Indicates that you press the button <b>briefly</b> .
	Indicates that you press the button <b>briefly and repeatedly</b> until an option you want is selected.
	Indicates that you press one of the buttons.
	Indicates that you <b>press and hold</b> the button for a specified period. The number inside the arrow indicates the period of a press (in the example, 2 seconds).
	Indicates that you turn the control toward the specified direction(s).
	Indicates that this operation is only possible using the remote control.
	Indicates that this operation is only possible using the main unit.

## Precautions

### Installation

- Install the System in a location with adequate ventilation to prevent internal heat build-up in the System.



DO NOT install the System in a location near heat sources, or in a place subject to direct sunlight, excessive dust or vibration.

- Install in a place which is level, dry and neither too hot nor too cold—between 5°C and 35°C (41°F and 95°F).
- Leave sufficient distance between the System and the TV.
- Keep the speakers away from the TV to avoid interference with the TV.

### Power sources

- When unplugging the System from the wall outlet, always pull on the plug, not the AC power cord.



DO NOT handle the AC power cord with wet hands.

### Moisture condensation

Moisture may condense in the lenses on the System in the following cases:

- After starting to heat the room
- In a damp room
- If the System is brought directly from a cold to a warm place.

Should this occur, the System may malfunction. In this case, leave the System turned on for a few hours until the moisture evaporates, unplug the AC power cord, then plug it in again.

### Internal heat

- Make sure there is good ventilation around the System. Poor ventilation could overheat and damage the System. —A cooling fan is inside the System to prevent heat build-up.



DO NOT block the ventilation openings or holes. If they are blocked by a newspaper or cloth, etc., the heat may not be able to get out.

### Others

- Should any metallic object or liquid fall into the System, unplug the AC power cord and consult your dealer before operating any further.



DO NOT disassemble the System since there are no user serviceable parts inside.

- If you are not going to operate the System for an extended period of time, unplug the AC power cord from the wall outlet.

If anything goes wrong, unplug the AC power cord and consult your dealer.

## Contents

<b>Connections</b> .....	<b>3</b>
Connecting a USB Mass storage class device .....	6
Preparing the Remote Control .....	6
Canceling the Demonstration.....	6
Changing the Color System .....	6
<b>Display Indication</b> .....	<b>7</b>
<b>Daily Operations—Playback</b> .....	<b>8</b>
Adjusting the Volume .....	9
Listening to the Radio.....	9
Playing Back a Disc/USB Mass Storage Class Device .....	10
Playing Back a Tape .....	12
<b>Daily Operations—Sound &amp; Other Adjustments</b> .....	<b>13</b>
Adjusting the Speaker Output Balance .....	13
Reinforcing the Bass Sound.....	13
Applying an Optimal Bass Sound Effect—VARIO BASS .....	13
Selecting the Sound Modes.....	14
Creating Your Own Sound Modes—User Mode.....	14
Creating 3-Dimensional Sound Field—3D Phonic .....	15
Presetting Automatic DVD Video	
Sound Increase Level.....	15
Changing the Picture Tone .....	15
Changing the Display Brightness .....	16
Setting the Clock.....	16
<b>Unique Video Disc/File Operations</b> .....	<b>17</b>
Selecting the Audio Track .....	17
Selecting the Subtitle Language .....	18
Selecting the View Angle .....	18
Reviewing the Playback Quickly.....	18
Special Picture Playback.....	19
<b>Advanced Playback Operations</b> .....	<b>20</b>
Programming the Playing Order—Program Play .....	20
Playing at Random—Random Play .....	21
Playing Repeatedly—Repeat Play .....	22
Prohibiting Disc Ejection—Child Lock .....	22
<b>On-Screen Operations</b> .....	<b>23</b>
On-screen Bar Information .....	23
Operations Using the On-screen Bar .....	24
Operations Using the Control Screen .....	27
<b>Recording Operations</b> .....	<b>29</b>
Recording onto a Tape.....	29
Dubbing Tapes.....	30
Synchronized Recording.....	30
<b>Enjoying Karaoke</b> .....	<b>31</b>
Singing Along (Karaoke).....	31
Adjusting the Sound Track for Karaoke .....	32
Scoring Your Karaoke Skill.....	32
Changing the Karaoke Setting.....	33
Reserving Karaoke Songs—Karaoke Program Play .....	34
<b>Timer Operations</b> .....	<b>35</b>
Setting the Timer .....	35
Turning Off the Power Automatically .....	36
Timer Priority .....	36
<b>Setup Menu Operations</b> .....	<b>37</b>
<b>Operating the TV</b> .....	<b>39</b>
<b>Additional Information</b> .....	<b>40</b>
Learning More about This System.....	40
Troubleshooting .....	44
Specifications.....	47
<b>Parts Index</b> .....	<b>48</b>

# Connections

**Do not connect the AC power cord until all other connections have been made.**

- Connect VIDEO OUT directly to the video input of your TV. Connecting VIDEO OUT to a TV via a VCR may interfere with your viewing when playing back a copy-protected source. Connecting VIDEO OUT to an integrated TV/VCR system may interfere with your viewing.

## Supplied accessories

- FM antenna (x1)
- AM loop antenna (x1)
- Composite video cord (x1)
- Remote control (x1)
- Batteries (x2)

If any item is missing, consult your dealer immediately.

**1** From the video input of TV/monitor  
See page 4.

**2** From the digital input of digital audio component  
See page 4.

**3** From AM/FM antenna  
See page 4.

**4** From the analog audio output of auxiliary equipment (VCR, etc.)  
See page 5.

**5** From the speakers and the subwoofer  
See page 5.

**6** To a wall outlet  
Plug the AC power cord only after all connections are complete.

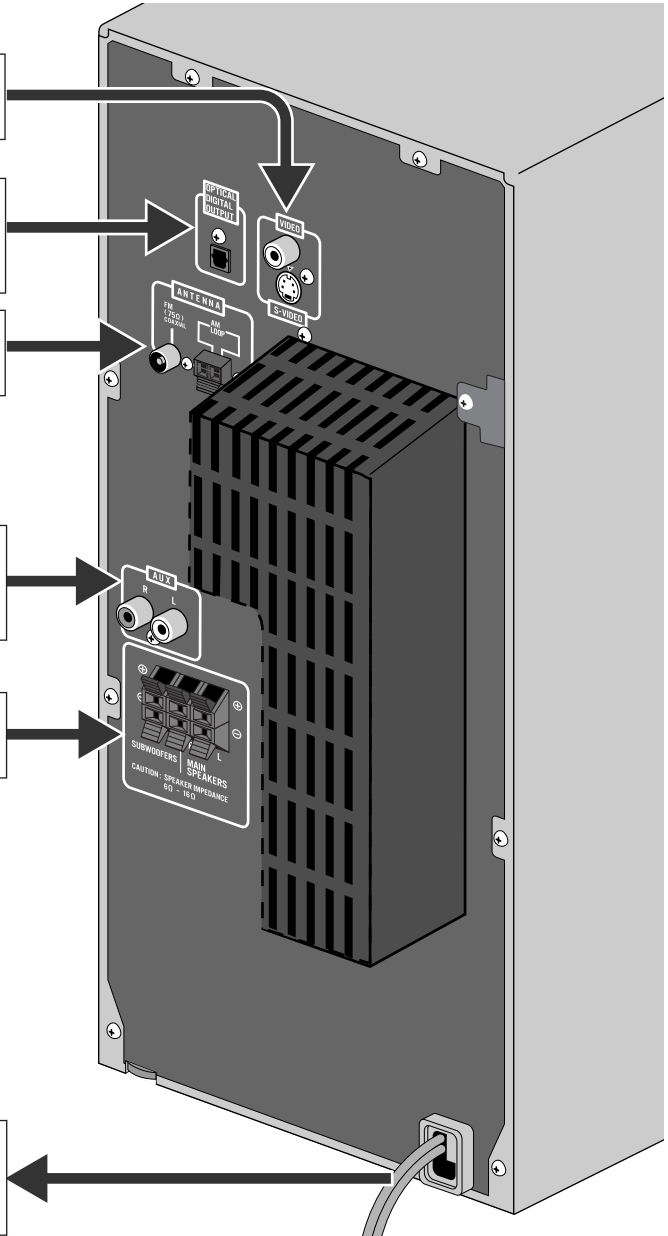



## 1 TV/monitor

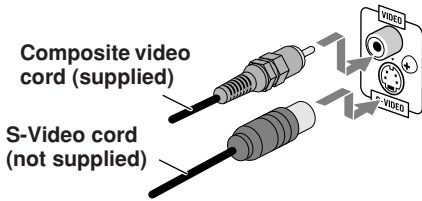

- Connect the VIDEO jack or S-VIDEO jack; whichever you want to use.
  - You can get better picture quality by connecting with S video cord.

## 2 Digital audio component

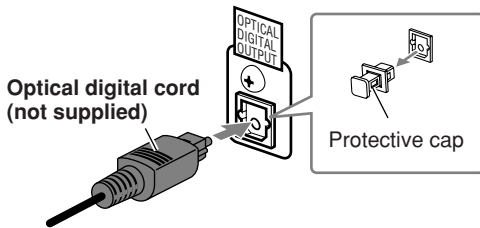

- Set “DIGITAL AUDIO OUTPUT” in the “AUDIO” menu correctly according to the connected digital audio equipment (see page 38).
- The digital signal through the OPTICAL DIGITAL OUTPUT terminal is transmitted only when “DVD/CD” is selected as the source.

## 3 AM/FM antenna

To assemble the AM loop antenna

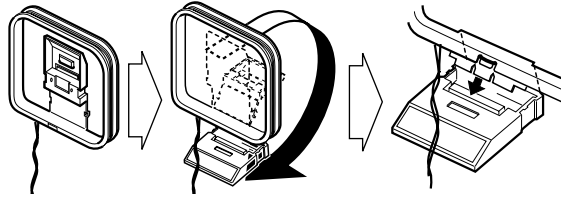

To connect AM/FM antenna

- If the antenna cord is covered with vinyl on the tip, twist and pull the vinyl off to remove.

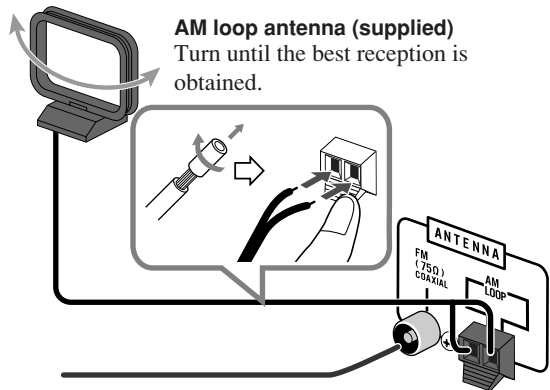

**AM loop antenna (supplied)**

Turn until the best reception is obtained.

**FM antenna (supplied)**

Extend it so that you can obtain the best reception.

For better FM reception

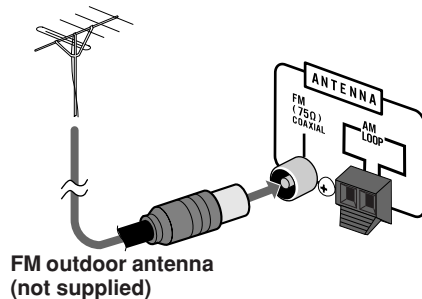

**FM outdoor antenna (not supplied)**

- Disconnect the supplied FM antenna, and connect an outdoor FM antenna using a 75  $\Omega$  wire with coaxial type connector.
- Make sure the antenna conductors do not touch any other terminals, connecting cords or the power cord. Also, keep the antennas away from metallic parts of the System, connecting cords, and the AC power cord. This could cause poor reception.

## 4 Auxiliary equipment

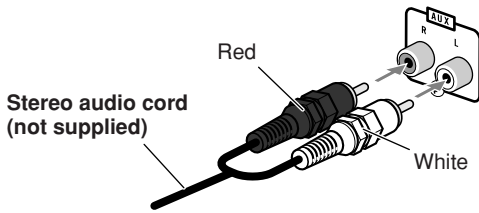

## 5 Speakers and the subwoofer

### To connect the speaker cords

- When connecting the speaker cords, match their polarity with that of the speaker terminals: blue/red to (+) and black to (-).

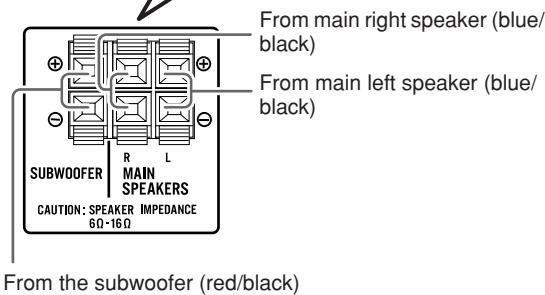
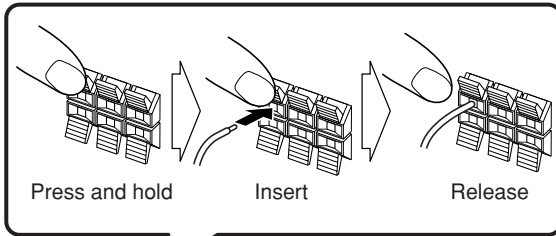

- Use only speakers with the same speaker impedance as indicated by the speaker terminals on the rear of the System.
- The main speakers and subwoofer are magnetically shielded to avoid color distortions on TVs. However, if not installed properly, it may cause color distortions. So, pay attention to the following when installing the speakers.

- When placing the speakers near a TV set, turn off the TV's main power switch or unplug it before installing the speakers.

Then wait at least 30 minutes before turning on the TV's main power switch again.

Some TVs may still be affected even though you have followed the above instruction. If this happens, move the speakers away from the TV.



- DO NOT connect more than one speaker to each terminal.
- DO NOT push or pull the speakers as this will damage the foot spacers at the bottom of the speakers.

## 6 Power cord

Plug the AC power cord to a wall outlet.

## Connecting a USB Mass storage class device

You can connect a USB mass storage class device such as a USB flash memory, hard disk drive, multimedia card reader, digital camera, etc. to this System.

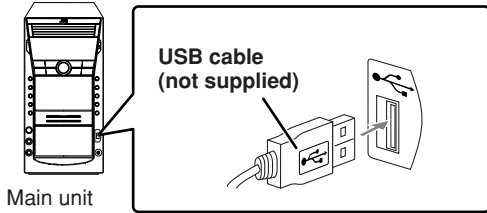

- You cannot connect a personal computer to the (USB MEMORY) terminal of the System.
- When connecting with a USB cable, use the USB 2.0 cable whose length is less than 1 m (3.3 ft).

## Preparing the Remote Control

Insert the batteries into the remote control by matching the polarity (+ and -) correctly.

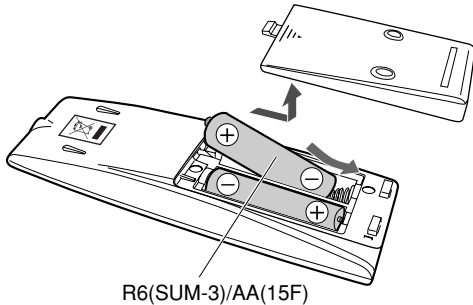

**When using the remote control**, point the top of the remote control toward the remote sensor as directly as possible. If you operate it from a diagonal position, the operating range (approx. 5 m/16.4 ft) may be shorter.

- If the range of effectiveness of the remote control decreases, replace both batteries.

### Caution:

Battery shall not be exposed to excessive heat such as sunshine, fire or the like.

## Canceling the Demonstration

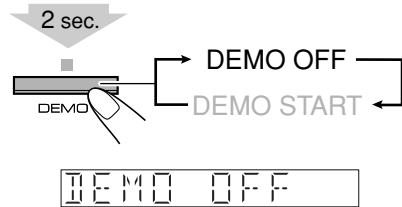

To start the demonstration, select DEMO START.

## Changing the Color System



You can select the video output to match it to the color system of your TV (NTSC or PAL).

- You can change the setting only while playback is stopped.

### 1 Enter the color system setting mode.



### 2 Select the color system.

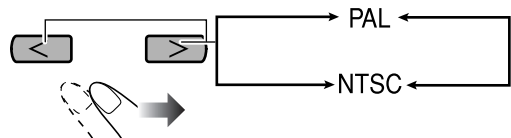

### 3 Store the setting.

ENTER/SET



# Display Indication

The indications on the display tell you a lot of things while you are operating the System. Before operating the System, be familiar with when and how the indicator illuminates on the display.

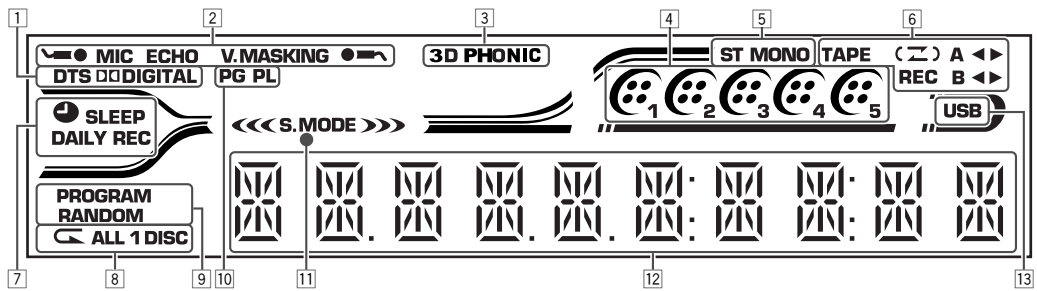

- 1 Source signal indicators
  - DTS: lights when DTS signals are detected.
  - DIGITAL: lights when Dolby Digital signals are detected.
- 2 Karaoke operation indicators
  - /MIC/: lights when Mic Mixing is activated; flashes when Karaoke Scoring is in use.
  - ECHO: lights when Echo is activated.
  - V.MASKING: lights when Vocal Masking is activated.
- 3 3D PHONIC indicator
  - Lights when 3D Phonic is activated.
- 4 Disc indicators
  - 1 – 5: lights to indicate the current disc tray.
  - : lights when a disc is detected on the disc tray; rotates during playback or pause.
- 5 FM reception indicators
  - ST (stereo): lights while an FM stereo station with sufficient signal strength is tuned in.
  - MONO: lights while receiving an FM stereo station in monaural.
- 6 Tape operation indicators
  - TAPE: lights when a tape is loaded in either deck A or B.
  - (Reverse Mode): indicates the current Reverse Mode.
  - A: lights when a tape is in deck A.
  - B: lights when a tape is in deck B.
  - \* (tape direction):
    - Lights to indicate the current tape running direction.
    - Flashes slowly during playback and recording.
    - Flashes quickly while rewinding a tape.
    - \* indicator for deck A is available only when the tape is being rewinded.
  - REC: lights while recording.
- 7 Timer indicators
  - : lights when Daily Timer or Recording Timer is on standby, is working, or being set.
  - SLEEP: lights when the Sleep Timer is activated.
  - DAILY: lights when the Daily Timer is on standby; flashes while working or being set.
  - REC: lights when the Recording Timer is on standby; flashes while working or being set.
- 8 Repeat mode indicators
  - : lights when Repeat Play is activated.
  - ALL: lights when All File Repeat is activated (only for USB)
  - ALL DISC: lights when All Disc Repeat is activated.
  - 1 DISC: lights when One Disc Repeat is activated.
  - 1: lights when One Track/Chapter/File/Step Repeat is activated.
- 9 Play mode indicators
  - PROGRAM: lights when Program Play is activated.
  - RANDOM: lights when Random Play is activated.
- 10 PG/PL indicator
  - PG: lights when Original Program is selected for DVD-VR playback.
  - PL: lights when Play List is selected for DVD-VR playback.
- 11 Sound Mode indicators
  - S.MODE: lights when one of the Sound Modes is activated.
  - : lights when one of the Sound Modes with surround effect is activated.
- 12 Main display
- 13 USB indicator
  - Lights when “USB” is selected as the source.

# Daily Operations—Playback

In this manual, the operations using the remote control are mainly explained; however, you can use the buttons and controls on the main unit if they have the same (or similar) name and marks.

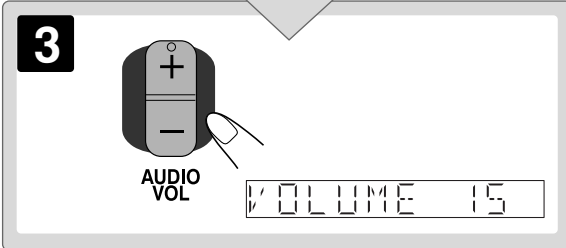
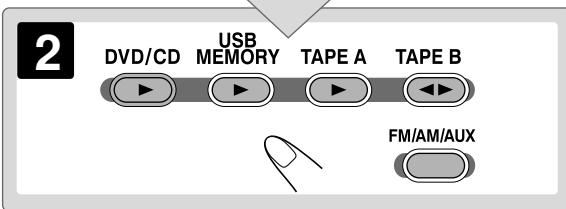
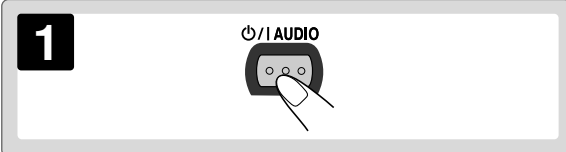
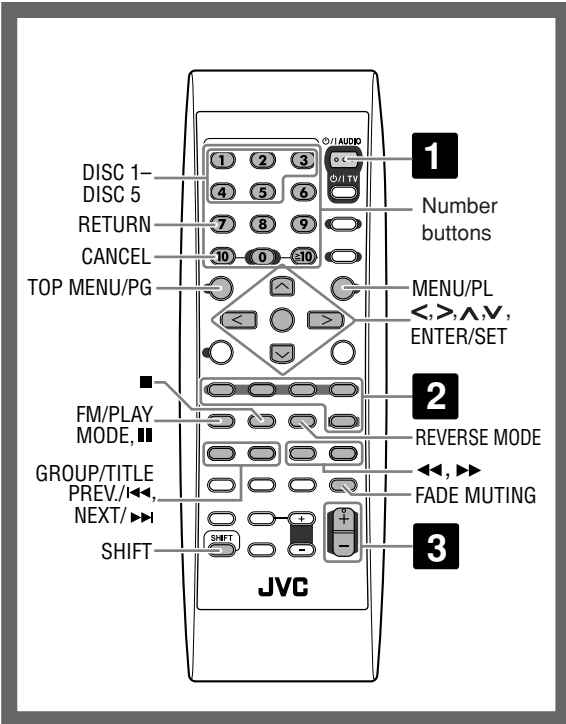

## 1 Turn on the power.

The STANDBY lamp on the main unit goes off.

- Without pressing **O/I AUDIO**, the System also turns on by pressing one of the source selecting buttons in the next step.

## 2 Select the source.

Playback automatically starts if the selected source is ready to start playback.

- To listen to the sound of the external component, press **FM/AM/AUX** repeatedly to select “AUX” as the source, then start playback on the external component.

## 3 Adjust the volume.

### To turn off (standby) the System

**O/I AUDIO** The STANDBY lamp on the main unit lights in red.



- A small amount of power is always consumed even while on standby.

### For private listening

Connect a pair of headphones to the PHONES jack on the main unit. The sound will no longer come out of the speakers. **Be sure to turn down the volume before connecting or putting on the headphones.**

- Disconnecting the headphones will activate the speakers again.



DO NOT turn off (standby) the System with the volume set to an extremely high level; otherwise, the sudden blast of sound can damage your hearing, speakers and/or headphones when you turn on the System or start playback.

### How to select a number

- 1** **2** **3** To select 5, press 5.
- 4** **5** **6** To select 10, press 10.
- 7** **8** **9** To select 15, press  $\geq 10$ , 1, then 5.
- 10** **0**  $\pm 10$  To select 30, press  $\geq 10$ , 3, then 0.
- To select 125, press  $\geq 10$ ,  $\geq 10$ , 1, 2, then 5.

## Adjusting the Volume

The volume level can be adjusted in 32 steps (VOLUME MIN, VOLUME 1 – VOLUME 30, and VOLUME MAX).

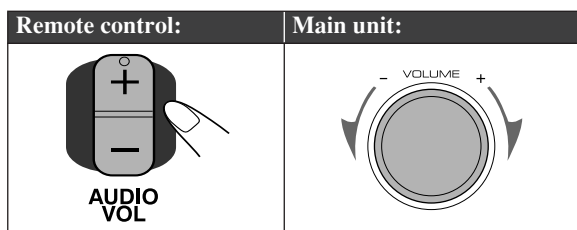

### To drop the volume in a moment

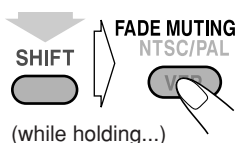

To restore the volume, press again or adjust the volume level.

## Listening to the Radio

INFO

### To select the band (FM/AM)

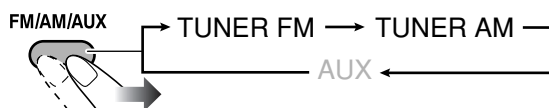

### To tune in to a station

While FM or AM is selected...

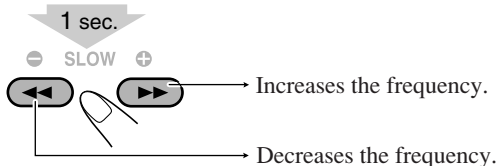

Frequency starts changing on the display.

When a station (frequency) with sufficient signal strength is tuned in, the frequency search stops.

- When you repeatedly press the button, the frequency changes step by step.

To manually stop the searching, press either button.

### If the FM reception is poor



The MONO indicator lights on the display. Reception will improve though stereo effect is lost—monaural reception mode.

To restore the stereo effect, press the button again (the MONO indicator goes off).

## To preset stations

You can preset 30 FM and 15 AM stations.

### 1 Tune in to a station you want to preset.

- You can also store the monaural reception mode for FM preset stations if selected.

### 2 Activate the preset number entry mode.

ENTER/SET



- Finish the following process while the indication on the display is flashing.
- To cancel the operation during procedure, press CANCEL while holding SHIFT.

### 3 Select a preset number for the station you store.

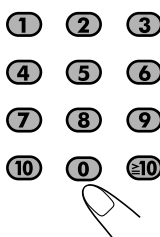

- To select a number, see “How to select a number” on page 8.
- You can also use ►►/◄◄ buttons.

### 4 Store the station.

ENTER/SET



## To tune in to a preset station

### 1 Select the band (FM or AM).

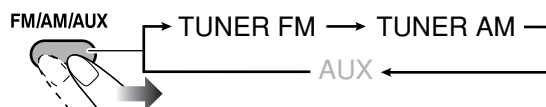

### 2 Select the preset number for the station you stored.

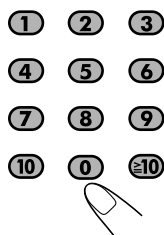

- To select a number, see “How to select a number” on page 8.
- You can also use ►►/◄◄ buttons.

## Playing Back a Disc/USB Mass Storage Class Device

INFO

**IMPORTANT:** Before playing a disc/USB mass storage class device, make sure of the following...

- Turn on the TV and select an appropriate input mode on the TV to view the pictures or on-screen displays.
- For disc/USB mass storage class device playback, you can change the initial setting to your preference. See “Setup Menu Operations” on page 37.

If “” appears on the TV screen when you press a button, the disc/USB mass storage class device cannot perform the operation you have tried to do.

- For playback of AV files, see also “Operations Using the Control Screen” on page 27.

### To insert discs

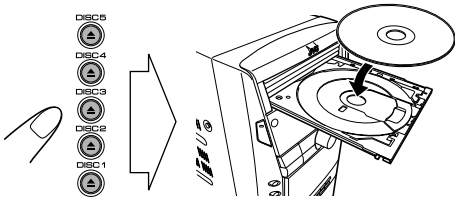

- When using an 8 cm (3-3/16 inches) disc, place it on the inner circle of the disc tray.

To close the disc tray, press the same  button again.





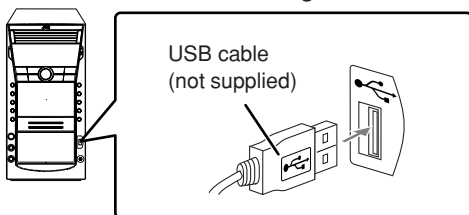

- If you press  for the same tray, the disc tray closes and playback starts automatically.

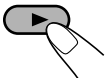

### To connect a USB mass storage class device

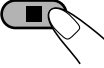

- Always set the volume to the minimum level when connecting or disconnecting the USB mass storage class device.
- To disconnect the USB mass storage class device safely, turn off the System before disconnecting the device.

## To play back disc/USB mass storage class device

To start:		
Disc	USB mass storage class device	
DVD/CD	USB MEMORY	Playback starts.
		
To pause:		To stop:
FM/PLAY MODE	To release it, press DVD/CD  or USB MEMORY  .	
		

While playing, this System can store the stop point (not applicable for CD). When you start playback again by pressing DVD/CD  or USB MEMORY , it starts from the position where you have stopped—Resume Play. (“RESUME” appears when you stop playback.)

To stop completely while Resume is activated, press  twice. (To cancel Resume, see “RESUME” on page 38.)

### On-screen guide icons

- During playback, the following icons may appear for a while on the TV screen:



Appears at the beginning of a scene containing multi-angle views.



Appears at the beginning of a scene containing multi-audio languages.



Appears at the beginning of a scene containing multi-subtitle languages.

- The following icons will also be shown on the TV screen to indicate your current operation.



- To deactivate the on-screen guide icons, see “ON SCREEN GUIDE” in “OTHERS” menu on page 38.

## To select a disc

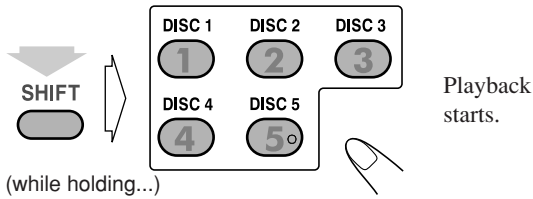

## To select a title/group

While playing...

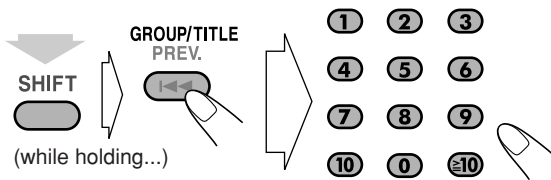

- To select a number, see “How to select a number” on page 8.

## To select a chapter/track

While playing...

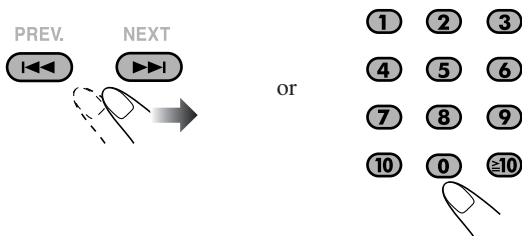

- The first time you press **PREV.**, you will go back to the beginning of the current chapter/track.
- To select a number, see “How to select a number” on page 8.

## To locate a particular portion

- This does not function for JPEG files.

While playing...

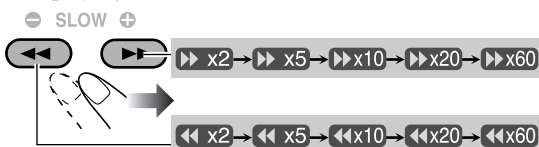

- Search speed changes as above for all discs/files except for MP3/WMA/WAV files. For MP3/WMA/WAV files, search speed is different.
- No sound comes out if searching is carried out while showing the moving picture.

To return to normal playback, press DVD/CD ► or USB MEMORY ►.

## To select an item directly

You can select a title/chapter/track directly and start playback.

- For DVD Video, you can select a **title before starting playback**, while you can select a **chapter after starting playback**.

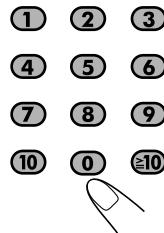

- To select a number, see “How to select a number” on page 8.

## To play back by using the disc menu

You can operate the disc play using the disc menu.

### ■ For DVD Video

#### 1 Show the disc menu.

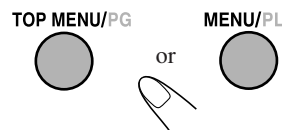

#### 2 Select an item on the disc menu.

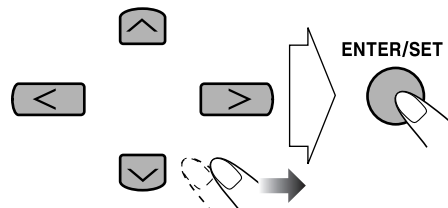

- On some discs, you can also select items by entering the number using the number buttons. To select a number, see “How to select a number” on page 8.



### ■ For SVCD/VCD with PBC

While playing a disc with PBC, "PBC" appears on the display instead of the playing time.

When disc menu appears on the TV screen, select an item on the menu. Playback of the selected item starts.

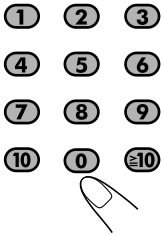

- To select a number, see "How to select a number" on page 8.

To move to the next or previous page of the current menu:	To return to the previous menu:

To cancel PBC, press ■, then press ►►.

- You can also cancel PBC by pressing ■, then pressing the number buttons. Playback starts with the selected track.

To reactivate PBC, press ■, then press ◀◀.

## Playing Back a Tape ●●●●●●●●

### To insert a tape

You can play back type I tapes.

- The use of C-120 or longer tapes is not recommended.

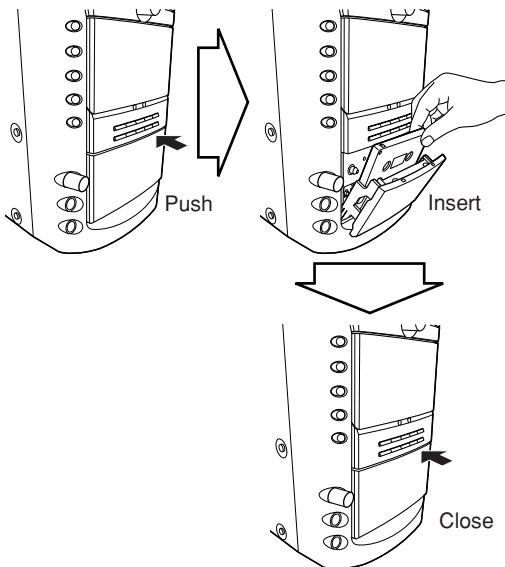

To start playback:	To stop:
To rewind or fast-forward tape:	

### To change the tape running direction (deck B only)

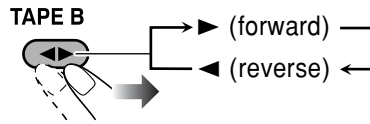

### To reverse the tape automatically (deck B only)

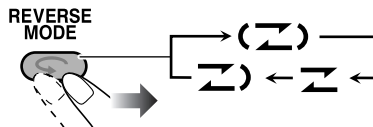

	Tape is reversed, and playback repeats until you stop it.
	Tape is not reversed. When the current side of the tape reaches its end, playback stops.
	Tape is reversed once.

# Daily Operations—Sound & Other Adjustments

## Remote Control

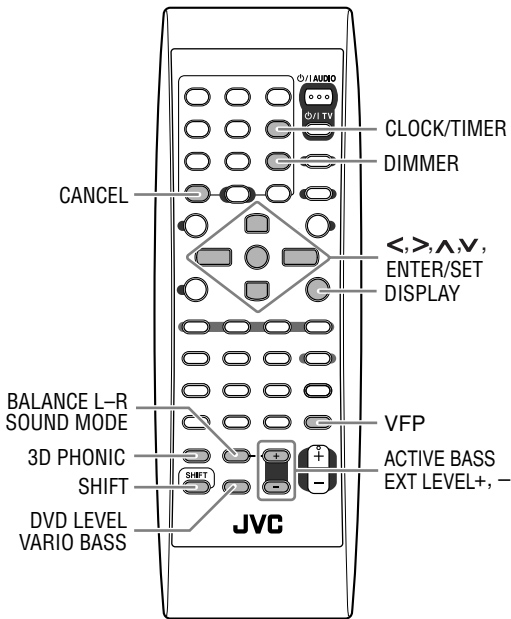

## Main unit

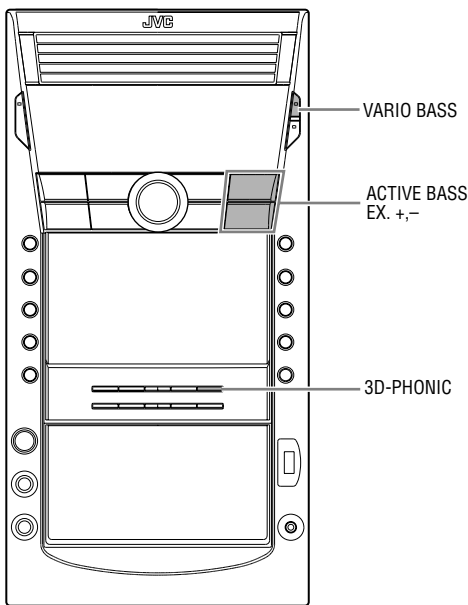

## Adjusting the Speaker Output

### Balance



You can adjust the speaker output balance.

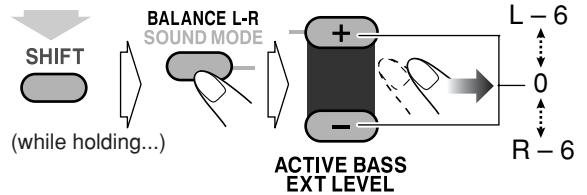

## Reinforcing the Bass Sound

INFO

You can adjust the Active Bass level from level 1 (minimum) to level 4 (maximum).

Initial setting: 4

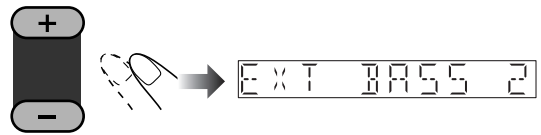

### ACTIVE BASS EXT LEVEL

- This function is not available when VARIO BASS is set to "OFF" or headphones are plugged in.

## Applying an Optimal Bass Sound Effect

### —VARIO BASS

VARIO BASS function adjusts bass sound characteristics to create a sound suitable for the playback source of your preference.

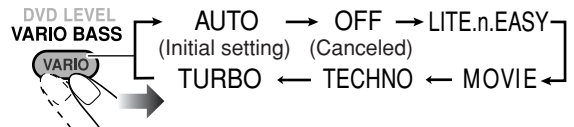

**AUTO** The System automatically applies TURBO, LITE.n.EASY, MOVIE or TECHNO according to the playback source (initial setting).

**LITE.n.EASY** Suitable for Karaoke and classical music. You can obtain a comfortable bass sound.

**MOVIE** Suitable for a video source and playback of external component. You can obtain a strong bass sound.

**TECHNO** Suitable for disco or techno music and playback of cassette tapes. You can obtain a strong bouncy bass sound.

**TURBO** Suitable for most kinds of music and playback of external component. You can obtain a balanced bass sound.

## Selecting the Sound Modes

You can select one of the preset Sound Modes.

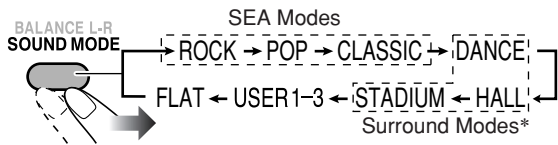

SEA (Sound Effect Amplifier) Modes	
<b>ROCK</b>	Boosts low and high frequency. Good for acoustic music (initial setting).
<b>POP</b>	Good for music with an emphasis on vocal.
<b>CLASSIC</b>	Good for classical music.
Surround Modes*	
<b>DANCE</b>	Increases resonance and bass.
<b>HALL</b>	Adds depth and brilliance to the sound.
<b>STADIUM</b>	Adds clarity and spreads the sound, as in an outdoor stadium.
User Modes	
<b>USER1/2/3</b>	Your individual mode stored in memory. See the next column "Creating Your Own Sound Modes—User Mode."

\* Surround elements are added to the SEA elements to create being-there feel in your room.

- While one of the Sound Modes is activated, S.MODE indicator lights up.
- While one of the Sound Modes with surround effect is activated, "« « « » » »" lights up.

To cancel the Sound Mode, select "FLAT."

## Creating Your Own Sound Modes

You can adjust the preset Sound Modes to create your own Sound Modes which suit your taste. The changed settings can be stored as the USER1, USER2 and USER3 Modes.

While "USER1," "USER2" or "USER3" is shown on the display...

**1**

ENTER/SET



**2** Select the SEA parameter you want to adjust.

- ① Adjust BASS.
- ② Adjust MID (Mid-range).
- ③ Adjust TRE (Treble).

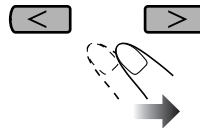

**3** Adjust the parameter.

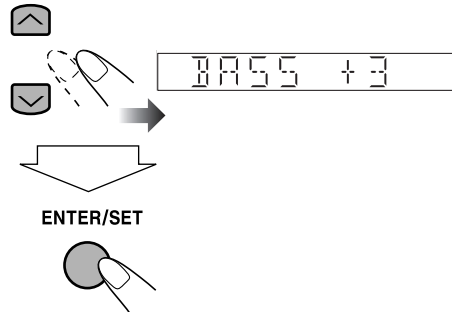

- You can adjust the bass, mid and treble level from -3 to +3.
- Repeat steps **2** and **3** to adjust the other parameters.

**4** Select one of the User Modes.

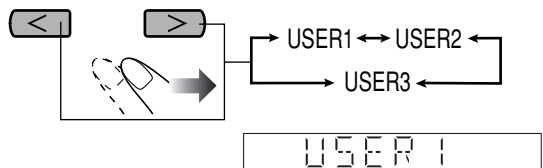

**5** Store the setting.

ENTER/SET



- You can adjust the SEA pattern temporarily by doing the operation on steps **1** to **3**. The adjustment is cleared when you change the sound mode to another mode.
- To create your own Sound Mode with surround effect, select DANCE, HALL or STADIUM first, then go through steps **1** to **5**.

## Creating 3-Dimensional Sound Field—3D Phonic

INFO

This function is available only for disc/USB mass storage class device playback.

While playing a disc/USB mass storage class device...

### 3D PHONIC

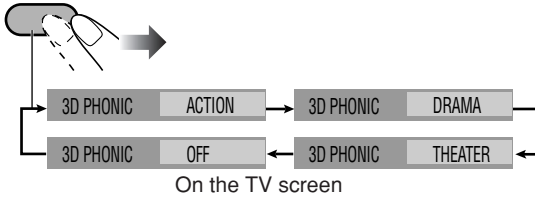

<b>ACTION</b>	Suitable for action movies and sports programs.
<b>DRAMA</b>	Creates natural and warm sound. Enjoy movies in a relaxed mood.
<b>THEATER</b>	Enjoy sound effects like in a major theater.

## Presetting Automatic DVD Video Sound Increase Level

Remote ONLY

The DVD Video sound is sometimes recorded at a lower level than other discs and sources. You can set the increase level for the currently loaded DVD Video, so you do not have to adjust the volume when you change the source.

- This function is available only for DVD Video discs.

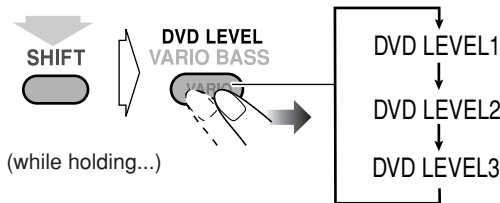

- As the number increases, sound level also increases.
- The initial setting is “DVD LEVEL3.”

## Changing the Picture Tone

Remote ONLY

While viewing a playback picture on the TV, you can select the preset picture tone, or adjust it and store your own preference.

### To select a preset picture tone

- 1 While playing, display VFP setting screen.



On the TV screen

- 2 Select a preset picture tone.

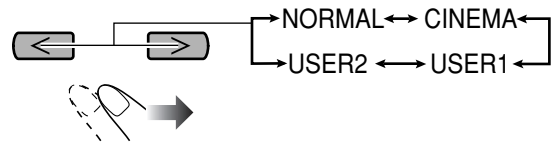

<b>NORMAL</b>	Normally select this.
<b>CINEMA</b>	Suitable for a movie source.
<b>USER1/USER2</b>	You can adjust parameters and can store the settings (see page 16).

## To adjust the picture tone

- 1 Select "USER1" or "USER2."
  - Follow steps 1 and 2 on page 15.
- 2 Select a parameter you want to adjust.

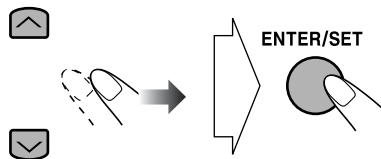

<b>GAMMA</b>	Adjust if the neutral color is bright or dark. The brightness of dark and bright portions is maintained (-3 to +3).
<b>BRIGHTNESS</b>	Adjust if the picture is bright or dark as a whole (-8 to +8).
<b>CONTRAST</b>	Adjust if the far and near position is unnatural (-7 to +7).
<b>SATURATION</b>	Adjust if the picture is whitish or blackish (-7 to +7).
<b>TINT</b>	Adjust if the human skin color is unnatural (-7 to +7).
<b>SHARPNESS</b>	Adjust if the picture is indistinct (-8 to +8).

- 3 Adjust the parameter.

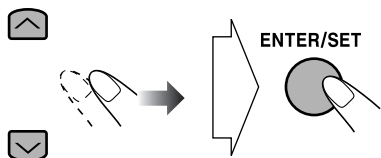

- 4 Repeat steps 2 to 3 to adjust other parameters.

To erase the VFP screen, press VFP again.

## Changing the Display Brightness

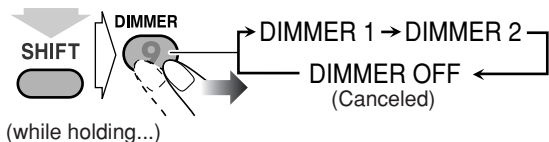

<b>DIMMER 1</b>	Dims the display.
<b>DIMMER 2</b>	Dims the display more than DIMMER 1.

## Setting the Clock

Without setting the built-in clock, you cannot use any timers except the Sleep timer.

- To exit from the clock setting, press CLOCK/TIMER as required.
- To correct a misentry during the process, press CANCEL while holding SHIFT. You can return to the previous step.

- 1 Activate clock setting mode.

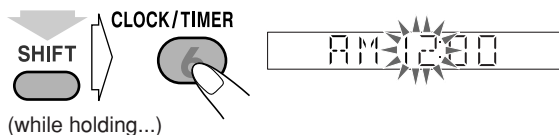

- If you have already adjusted the clock before, press the button repeatedly until the clock time starts flashing.

- 2 Adjust the hour, then minute.

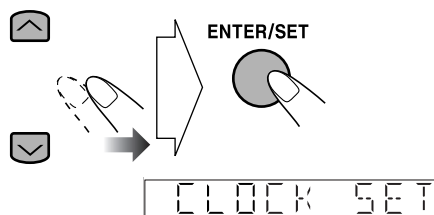

Now the built-in clock starts working.

### Changing the display information

For "DVD/CD" and "USB MEMORY":

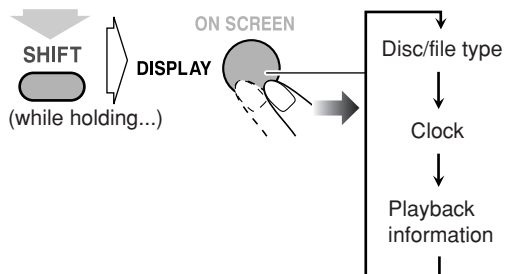

For "TAPE," "TUNER FM," "TUNER AM" and "AUX":

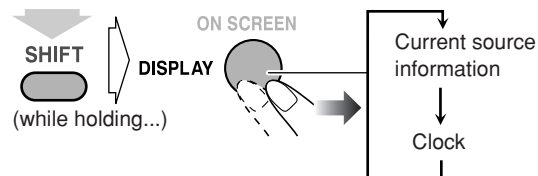

# Unique Video Disc/File Operations

## Remote Control

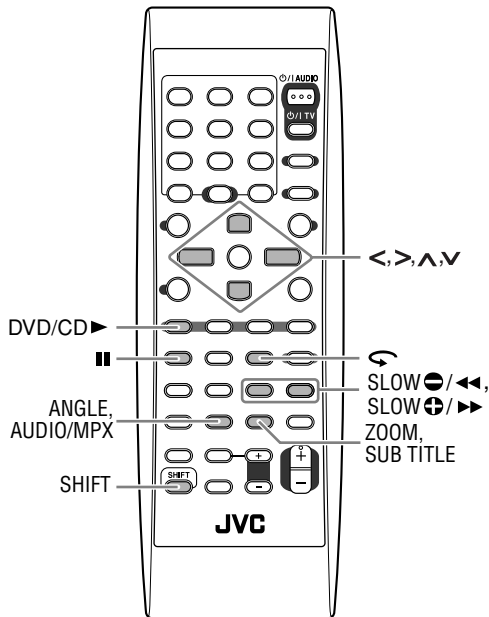

## Selecting the Audio Track



**For DVD Video:** While playing back a chapter containing audio languages, you can select the language to listen to.

**For DVD-VR/SVCD/VCD:** While playing back a chapter/track, you can select the audio channel to play.

- You can also select the audio track using the on-screen bar (see page 24).

### ANGLE AUDIO/MPX



While playing DVD Video...

Ex.:

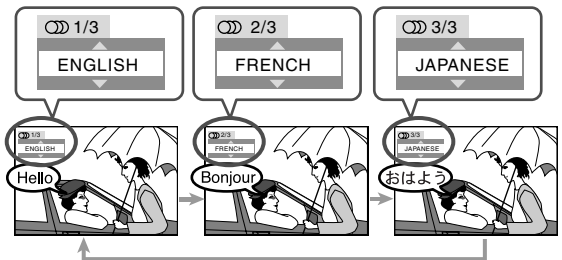

While playing a DVD-VR, SVCD or VCD...

### ANGLE AUDIO/MPX

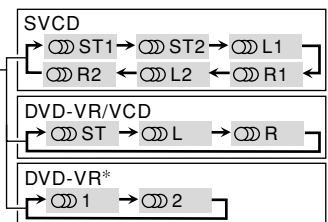

**ST1/ST2/ST** To listen to normal stereo (2-channel) playback.

**L1/L2/L** To listen to the left audio channel.

**R1/R2/R** To listen to the right audio channel.

\* Example: when two multi-channel streams are recorded.

- SVCD can have 4 audio channels. SVCD usually uses these 4 channels to record two 2-channel recordings (ST1/ST2).

## Selecting the Subtitle Language

**For DVD Video:** While playing back a chapter containing subtitles in different languages, you can select the subtitle language to display on the TV screen.

**For DVD-VR:** While playing, you can turn the subtitle on or off.

**For SVCD:** While playing, the SUB TITLE button functions even if no subtitles are recorded on the disc.

- You can also select the subtitle language using the on-screen bar (see page 24).

**While playing a DVD Video...**

**1** Display the subtitle selection window.

ZOOM  
SUB TITLE



**2** Select the subtitle language.

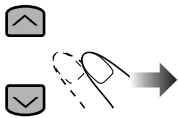

Ex.:

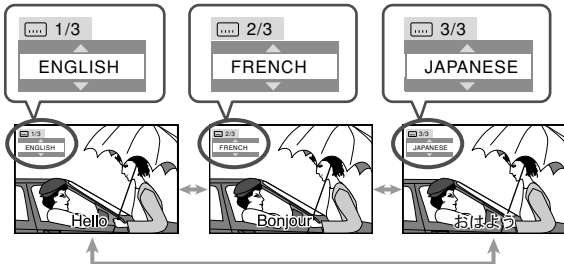

**While playing a DVD-VR...**

ZOOM  
SUB TITLE

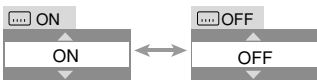

**While playing an SVCD...**

ZOOM  
SUB TITLE

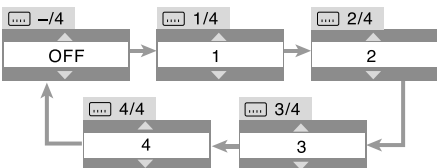

## Selecting the View Angle

**For DVD Video only:** While playing back a chapter containing multi-view angles, you can view the same scene from different angles.

- You can also select the view angle using the on-screen bar (see page 24).

**While playing...**

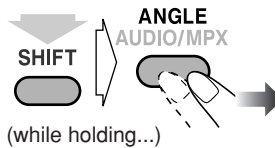

Ex.:

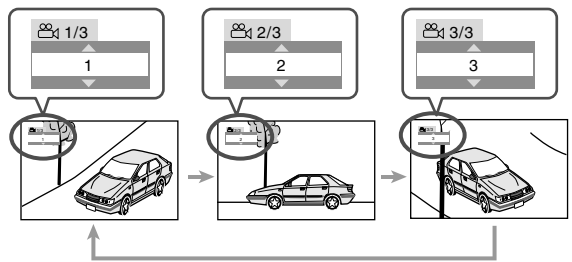

## Reviewing the Playback Quickly

**For DVD Video/DVD-VR only:** You can move back the playback position by 10 seconds (only within the same title)—Glance Back.

**While playing...**

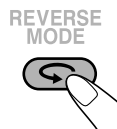

## Special Picture Playback

INFO

### Pause playback

While playing...

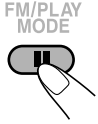

Playback pauses.

To resume normal playback, press DVD/CD ► or USB MEMORY ►.

### Frame-by-frame playback

• This function is not available for ASF file.

1 While playing...



Playback pauses.

2 Advance the still picture frame by frame.

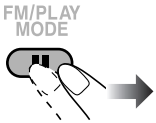

To resume normal playback, press DVD/CD ► or USB MEMORY ►.

## Slow-motion playback

• This function is available only for moving picture files except MPEG-1/MPEG-2/ASF.

1 While playing...



Still picture appears.

2 Start slow-motion playback.

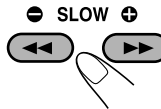

\*Only for DVD Video.

To resume normal playback, press DVD/CD ►.

## Zoom

• For JPEG/ASF files, see page 28.

While playing...

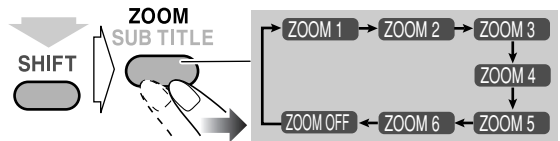

As the number increases, magnification also increases.

• You can move the zoomed-in area by pressing <, >, ^, v.

To cancel Zoom, press ZOOM repeatedly until “ZOOM OFF” appears on the TV screen.



# Advanced Playback Operations

## Remote Control

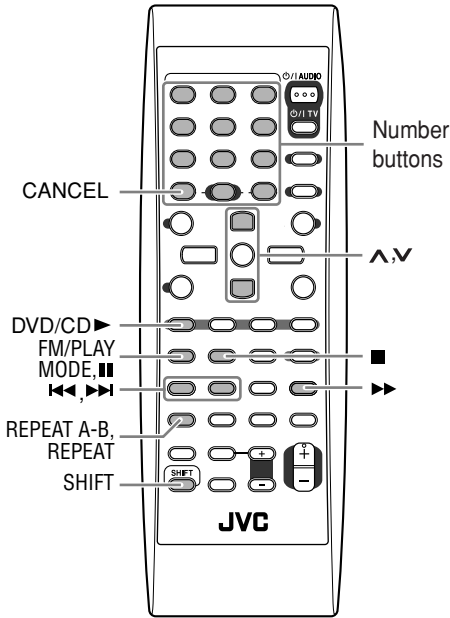

## Main unit

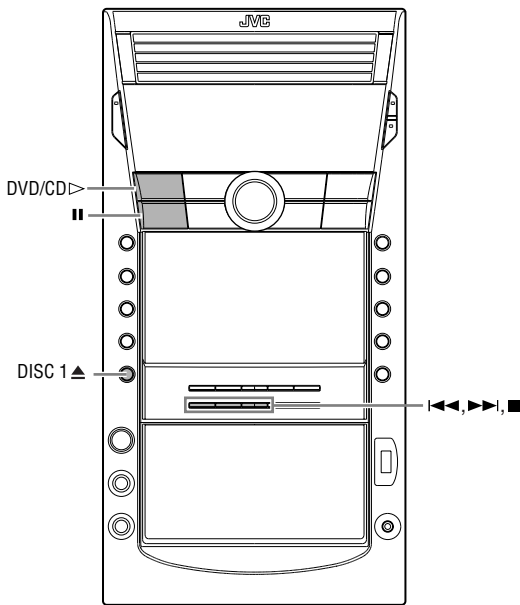

## Programming the Playing Order

### —Program Play



You can arrange the playing order of the chapters/tracks/files (up to 99) before you start playback.

- Program Play cannot be used for files in a USB mass storage class device, Video files/JPEG files on a disc and DVD-VR.

#### 1 Before starting playback, activate Program Play.

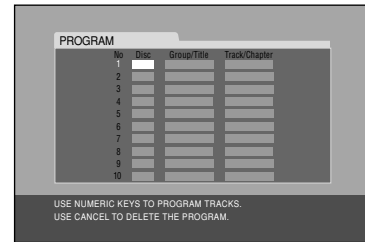
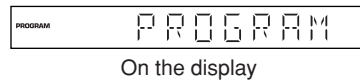

#### 2 Select chapters/tracks/files you want for Program Play.

- ① Select a disc number.
  - ② For DVDs and Audio files only: Select a group/title number.
  - ③ Select a track/chapter number.
- To select a number, see “How to select a number” on page 8.

#### 3 Repeat step 2 above until you complete your program.

#### 4 Start playback.



Playback starts in the order you have programmed.

To skip:	To pause:	To stop*:
	<p>To release, press DVD/CD ►.</p>	

\* Resume does not work for Program Play.

### To check the programmed contents

Before or after playback...

- In the reverse order.
- In the programmed order.

### To modify the program

Before or after playback...

To erase the last step:	To erase the entire program:
<p>(while holding...)</p>	
<b>To add steps in the program:</b> Repeat step 2 on page 20.	

### To exit from Program Play

Before or after playback...



## Playing at Random—Random Play

You can play the contents of all the loaded discs at random.

- Random Play cannot be used for files in a USB mass storage class device, Video files/JPEG files on a disc, DVD-VR and some DVDs.

### 1 Before starting playback, activate Random Play.

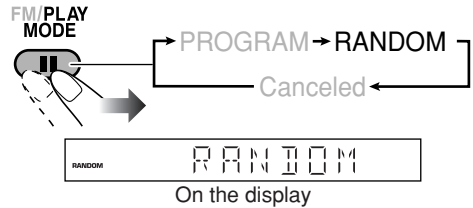

### 2 Start playback.



Playback of the current disc starts in a random order. When all chapters/tracks on the current disc are played, playback of the next disc starts. Random Play ends when all loaded discs are played.

To skip:	To pause:	To stop:
<p>To go to the beginning of the current chapter/track, press ◀◀.</p>	<p>To release, press DVD/CD ►.</p>	

### To exit from Random Play

Before or after playback...



## Playing Repeatedly—Repeat Play

You can repeat playback.

- You can also select the repeat mode using the on-screen bar (except when playing back AV files or JPEG files). For on-screen operations, see page 25.
- For Video file/JPEG file and DVD-VR, see page 28.
- The indicator(s) lights on the display as follows to indicate the current repeat mode.

### Repeat Play

#### • For DVD Video:

While playing...

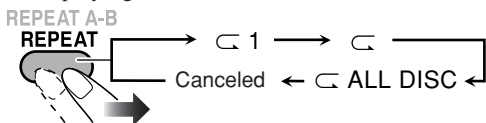

#### • For Audio files (MP3/WMA/WAV):

While playing or before playback...

When repeating Audio files on disc:

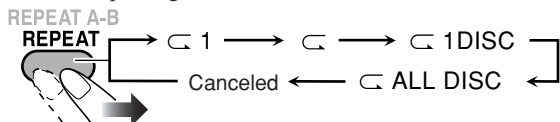

When repeating Audio files in a USB mass storage class device:

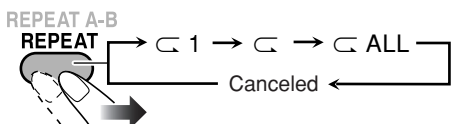

#### • For CD/SVCD/VCD:

While playing or before playback (without PBC for SVCD/VCD)...

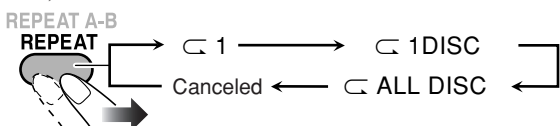

#### • For Random Play:



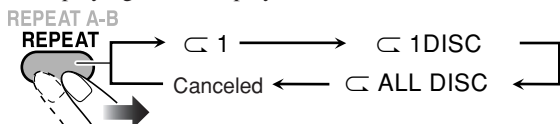

While playing or before playback...

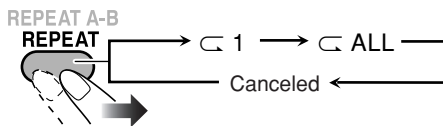

#### • For Program Play:

While playing or before playback...



 1	Repeats the current chapter/track/file.
 ALL	Repeats the current title/group.
 1 DISC*	Repeats the current disc.
 ALL DISC*	Repeats all discs.
 ALL	Repeats all files in a USB mass storage class device or all programmed chapters/tracks/files.

\*These modes may not work correctly for DVDs.

### A-B Repeat

You can repeat playback of a desired portion by specifying the beginning (point A) and the ending (point B).

- A-B Repeat cannot be used for AV files and some DVDs.

#### 1 While playing (without PBC for SVCD/VCD), select the start point (A).

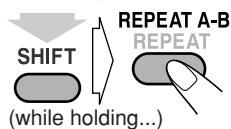

#### 2 Select the end point (B).

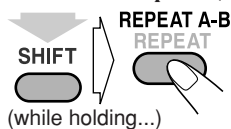

- You can search for the end point using the  button.

**To cancel A-B Repeat**, press REPEAT A-B again.

- A-B Repeat will also be canceled when you stop play or skip the chapter or track.

### Prohibiting Disc Ejection—Child Lock

You can lock the disc trays so that no one can eject the loaded discs.

While on standby...

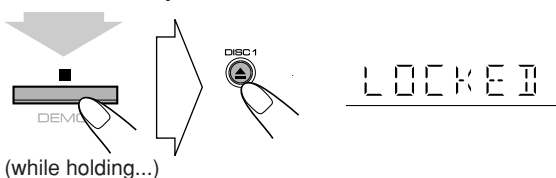

(while holding...)

**To cancel the prohibition**, repeat the same procedure.

“UNLOCKED” appears on the display.

# On-Screen Operations

## Remote control

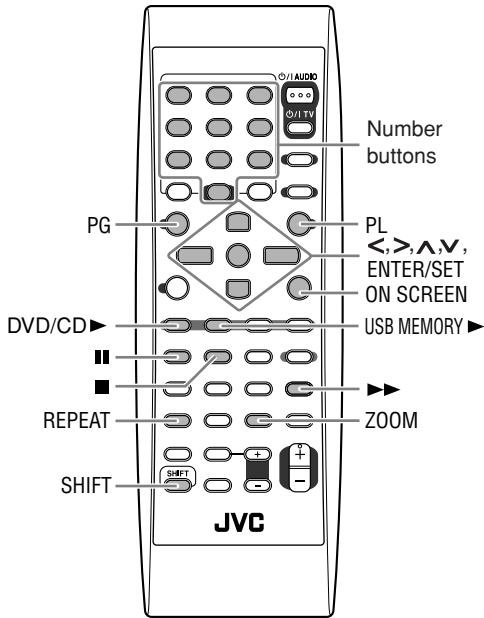

## On-screen Bar Information

You can check the playback information and use some functions through the on-screen bar (except when playing back Audio files or JPEG files).

### On-screen bars

#### DVD Video

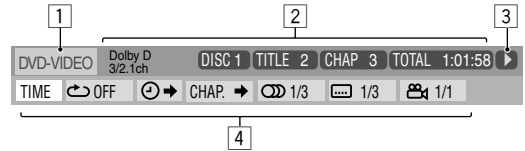

#### DVD-VR

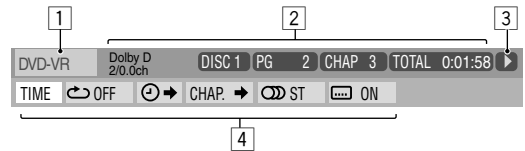

#### SVCD

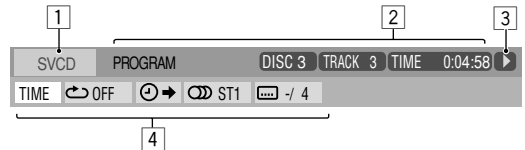

#### VCD



#### CD

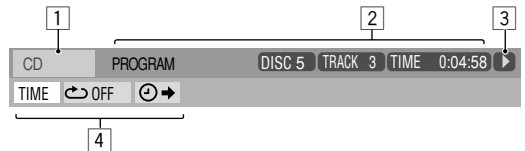

#### Video file on a disc—MPEG-1/MPEG-2/ASF file



#### Video file in a USB mass storage class device—MPEG-1/MPEG-2/ASF file



## 1 Disc type/source type

## 2 Playback information

### Indication Meanings

Dolby D/  
DTS/LPCM Audio format

3/2.1 ch/  
2/0.0 ch Channel number

PROGRAM/  
RANDOM Current play mode

**DISC 1** Current disc

**TITLE 2** Current title

**CHAP 3** Current chapter

**PG 2** Current program

**PL 2** Current play list

**TOTAL 1:25:58** Time indications

## 3 Playback conditions

### Indication Meanings

Playback

Forward/Reverse search

Forward/Reverse slow-motion

Pause

Stop

## 4 Operation icons (on the pull-down menu)

### Indication Meanings

Select to change the time indication (see also page 25).

Select to repeat playback (see also page 25).

Select for time search (see also page 26).

Select for chapter search (see also page 26).

Select to change the audio language or channel (see also page 17).

Select to change subtitle language (see also page 18).

Select to change view angle (see also page 18).

## 5 Repeat Play setting for video files (See also page 28)

## Operations Using the

## On-screen Bar



Basic operation procedures through the on-screen bar are as follows:

Ex.: Selecting a subtitle (French) for DVD Video:

While a disc is selected as the source...

### 1 Display the on-screen bar with the pull-down menu.

ON SCREEN

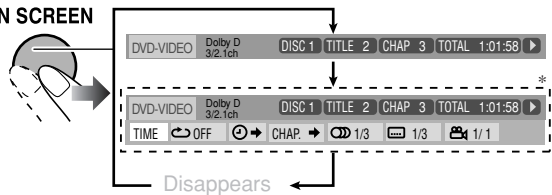

\* This does not appear for Video files.

### 2 Select (highlight) the item you want.



### 3 Display the pop-up window.

ENTER/SET



### 4 Select the desired option in the pop-up window.

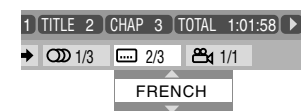
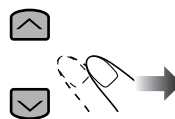

### 5 Finish the setting.

ENTER/SET Pop-up window disappears.



To erase the on-screen bar, press ON SCREEN again.

## To change the time information

You can change the time information in the on-screen bar and the display window on the main unit.

### 1 Display the on-screen bar with the pull-down menu.



### 2 Make sure **TIME** is selected (highlighted).

### 3 Change the time indication.

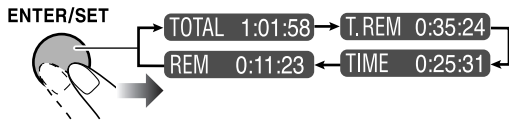

<b>TOTAL</b>	Elapsed disc time.
<b>T. REM</b>	Remaining time of the current disc/title.
<b>TIME*</b>	Elapsed playing time of the current chapter/track.
<b>REM*</b>	Remaining time of the current chapter/track.

\*Not selectable for DVD-VR.

## Repeat Play

- For Audio files, see also page 22.
- For Video files and JPEG file, see page 28.

### 1 While playing a disc (without PBC for SVCD/VCD), display the on-screen bar with the pull-down menu.

- All discs except DVD: Repeat Play can be selected before starting playback.

### 2 Select .

### 3 Display the pop-up window.



### 4 Select the repeat mode you want.

<b>ALL</b>	Repeats all discs or all programmed tracks.
<b>A-B</b>	Repeats a desired portion (see below).
<b>TITLE</b>	Repeats the current title.
<b>DISC</b>	Repeats the disc (except for DVD).
<b>CHAPTER</b>	Repeats the current chapter.
<b>TRACK*</b>	Repeats the current track.
<b>PG</b>	Repeats the current program (for DVD-VR only). See also page 28.
<b>PL</b>	Repeats the current play list (for DVD-VR only). See also page 28.
<b>OFF</b>	Cancels Repeat Play.

\* During Program Play or Random Play, "STEP" appears.

### 5 Finish the setting.

**ENTER/SET** Pop-up window disappears.



## A-B Repeat

### 1 While playing a disc, display the on-screen bar with the pull-down menu.

### 2 Select .

### 3 Display the pop-up window.



### 4 Select "A-B."



### 5 Select the start point (A).

**ENTER/SET**



- After selecting the starting point (A), you can search for the end point using .

## 6 Select the end point (B).

ENTER/SET



A-B Repeat starts. The selected portion plays repeatedly.

To cancel A-B Repeat, repeat steps 1 to 3, and select “OFF” in step 4.

## Time Search

You can move to a particular point by specifying the elapsed playing time from the beginning.

### 1 While playing a disc (without PBC for SVCD/VCD), display the on-screen bar with the pull-down menu.

- All discs except DVD: Time Search can be used before starting playback.

### 2 Select .

### 3 Display the pop-up window.



### 4 Enter the time.

You can specify the time in hours/minutes/seconds.

**Examples:**

To move to a point of 1 (hours):  
02 (minutes): 00 (seconds), press  
1, 0, 2, 0, then 0.

To move to a point of 54  
(minutes): 00 (seconds), press 0,  
5, 4, 0, then 0.

- It is always required to enter the hour digit (even “0” hour), but it is not required to enter trailing zeros (the last two digits in the examples above).
- To correct a misentry, press < to erase the last entry.

### 5 Finish the setting.

ENTER/SET



The System starts playing from the specified time.

## Chapter Search

**For DVD Video/DVD-VR only:** You can search for the chapter number to play.

### 1 While playing a disc, display the on-screen bar with the pull-down menu.

### 2 Select .

### 3 Display the pop-up window.

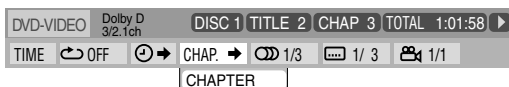

### 4 Enter the desired chapter number.

**Examples:**

To select 5, press 5.

To select 15, press 1, then 5.

To select 30, press 3, then 0.

- To correct a misentry, press the number buttons until the desired number is shown in the pop-up window.

### 5 Finish the setting.

ENTER/SET



The System starts playing the searched chapter.

## Operations Using the Control

### Screen



For DVD-VR, JPEG file and AV files: You can search for and play the desired items through the control screen.

### Control screen for DVD-VR

The control screen is superimposed on the TV screen when you call up Original Program (PG) or Play List (PL) screens.

#### To select playback type

To select the Original Program:	To select the Play List:
<p>TOP MENU/PG</p>	<p>MENU/PL</p>

When Original Program screen is superimposed.

ORIGINAL PROGRAM					
No	Date	Ch	Time	Title	
1	04/25/07	4ch	7:00 PM	JVC DVD World 2004	
2	05/17/07	8ch	10:30 AM		
3	05/22/07	8ch	5:00 PM	Music Festival	
4	05/26/07	L-1	1:19 PM	children 001	
5	06/20/07	4ch	10:00 PM		
6	06/25/07	L-1	8:23 AM	children 002	

When Play List screen is superimposed.

PLAY LIST				
No	Date	Chap	Length	Title
1	05/25/07	001	1:03:16	My JVC World
2	06/17/07	005	1:35:25	
3	06/20/07	003	0:10:23	Favorite music
4	06/25/07	001	0:07:19	children001-002

- ① Program/Play list number
- ② Recording date
- ③ Recording source (TV station, the input terminal of the recording equipment, etc.)
- ④ Start time of recording
- ⑤ Title of the program/play list\*
- ⑥ Highlight bar (current selection)
- ⑦ Creating date of play lists
- ⑧ Number of chapters
- ⑨ Playback time

\*The title of the original program or play list may not be displayed depending on the recording equipment.

To remove the control screen, press ENTER/SET.

### Control screen for AV files/JPEG files

The control screen automatically appears on the TV screen when the System detects Audio files on the loaded disc or connected USB mass storage class device. (For Video files/JPEG files; it appears when playback is stopped.)

Ex.: While playing an MP3 file on a disc.

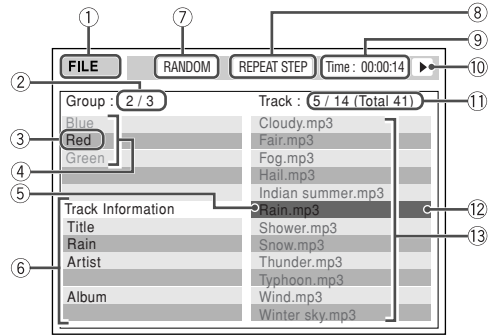

- ① Current source  
FILE: Current source is "DVD/CD."  
USB: Current source is "USB."
- ② Current group number/total group number
- ③ Current group
- ④ Group list
- ⑤ Current file
- ⑥ File information (only for MP3/WMA/WAV file)
- ⑦ Play mode information (RANDOM or PROGRAM, not applicable for USB mass storage class device.)
- ⑧ Repeat Play setting
- ⑨ Elapsed playing time of the current file (except JPEG files)
- ⑩ Operation Status icon
- ⑪ Current file number/total number of files in the current group (total number of files on the current disc/USB mass storage class device)
- ⑫ Highlight bar (Current selection)
- ⑬ File list
  - If different types of files (Audio files, Video files and Still picture files) are recorded on a disc/USB mass storage class device, select the file type to play (see page 37).

#### To move the highlight bar between group list and file list (only for AV files and JPEG file):

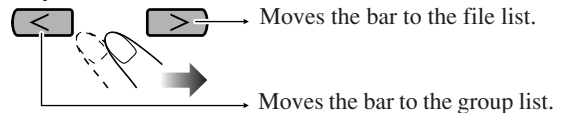

#### To select an item in the list:





Move the highlight bar to the desired item.

- If you move the highlight bar while playing back DVD-VR or Audio files, the selected item starts playback automatically.

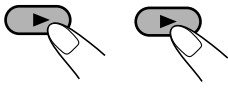

## To start playback

For JPEG files:	
<b>ENTER/SET</b> 	The selected file (still picture) is displayed until you change it.
<b>DVD/CD</b> <b>USB MEMORY</b> 	Slide-show playback starts. Each file (still picture) is shown on the screen for a few seconds, then changes one after another.
For the other files:	
<b>ENTER/SET</b> 	Playback starts with the selected chapter/file. <ul style="list-style-type: none"> <li>Pressing <b>DVD/CD</b> ► or <b>USB MEMORY</b> ► also starts playback.</li> </ul>

- Once you start viewing a JPEG file or Video file, the control screen disappears.
- To cancel slide-show for JPEG file, and display the current still picture, press **II**.

## To stop playback

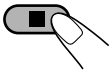

## To repeat chapter/program/play list for DVD-VR

While playing or before starting playback...

### For Original Program

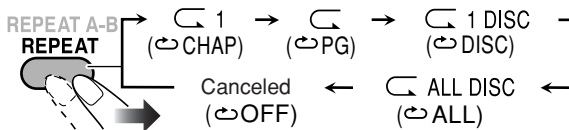

### For Play List

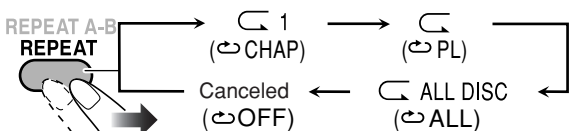

<b>1*</b>	Repeats the current chapter.
<b>*</b>	Repeats the current program/play list.
<b>1 DISC*</b>	Repeats all programs on the current disc.
<b>ALL DISC</b>	Repeats all loaded discs.

\* Not available before starting playback.

## To repeat slide-show for JPEG files

While playing or before starting playback...

- When repeating JPEG file on disc:

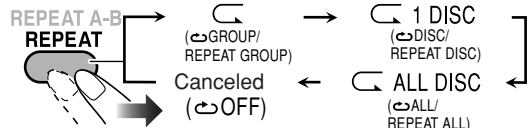

- When repeating JPEG files in a USB mass storage class device:

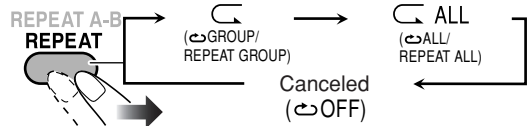

## To repeat play for Video files

While playing or before starting playback...

- When repeating Video files on disc:

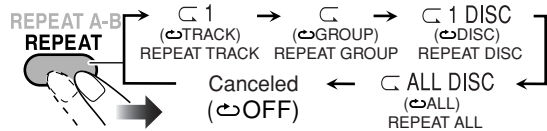

- When repeating Video files in a USB mass storage class device:



<b>1</b>	Repeats the current file.
<b>1</b>	Repeats the current group.
<b>1 DISC</b>	Repeats all files on the current disc.
<b>ALL</b>	Repeats all files in the USB mass storage class device.
<b>ALL DISC</b>	Repeats all loaded discs.

- For Repeat Play of Audio file, see page 22.

## To zoom in the JPEG/ASF file

While playing...

- During slide-show for JPEG file, press **II** to display the still picture, then...

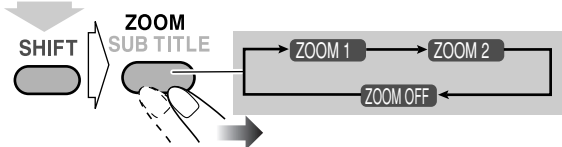

(while holding...)

As the number increases, magnification also increases.

- You can move the zoomed-in area by pressing **<**, **>**, **^**, **v**.

To cancel Zoom, press ZOOM repeatedly until "ZOOM OFF" appears on the TV screen.

# Recording Operations

## Main unit

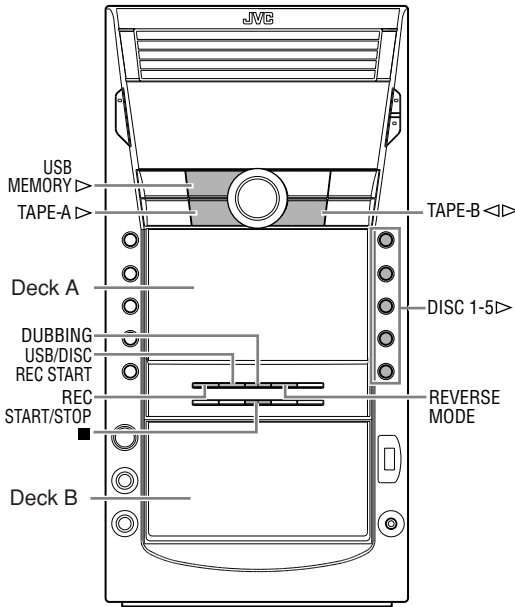

### IMPORTANT:

It should be noted that it may be unlawful to rerecord pre-recorded tapes, records, or discs without the consent of the owner of copyright in the sound or video recording, broadcast or cable program and in any literary, dramatic, musical, or artistic work embodied therein.

## Recording onto a Tape



You can use type I tapes for recording.

- To play a tape, see page 12.

### 1 Insert a recordable cassette into deck B.

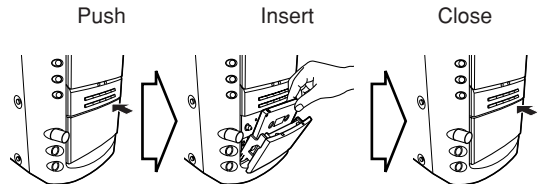

### 2 Check the tape running direction and Reverse Mode settings on the display.

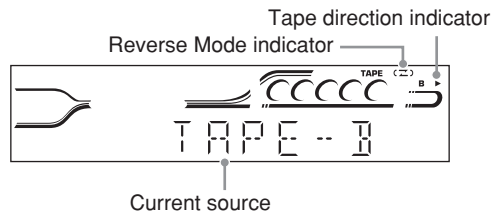

#### To change the direction

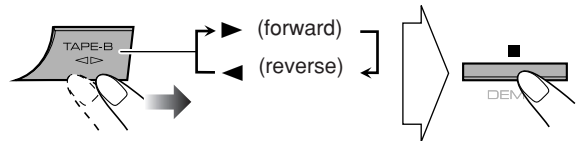

#### Change the Reverse Mode if necessary

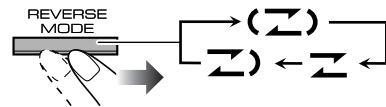

Z)	To record on both sides.
(Z)	• When using Reverse Mode, start recording in the forward (▶) direction.
Z	To record on only one side.

### 3 Start playing the source—"TUNER FM," "TUNER AM," "DVD/CD," "USB," "TAPE-A" or "AUX."

- When recording from a disc/USB mass storage class device, you can also use "Synchronized Recording" (see page 30).
- When recording from deck A, you can also use "Dubbing" (see "Dubbing Tapes" on page 30).

#### 4 Start recording.

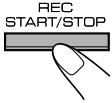

#### To stop recording

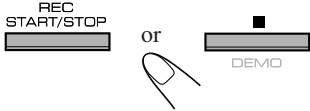

### Dubbing Tapes



You can record a tape from deck A to deck B.

#### 1 Change the source to “TAPE.”

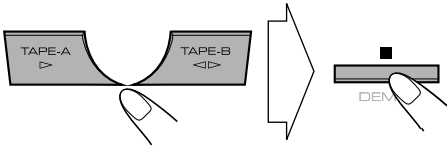

#### 2 Insert the source cassette in deck A, and a recordable cassette in deck B.

#### 3 Check the tape running direction on the display. See step 2 of “Recording onto a Tape” on page 29.

#### 4 Start dubbing.

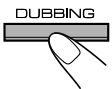

- When either tape playback or recording ends, both cassette decks stop at the same time.

#### To stop dubbing

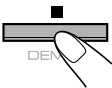

### Synchronized Recording



You can start and stop both playback and tape recording at the same time.

- This function is available only for CD/VCD/SVCD/DVD Video and Audio files.
- Not available with Random Play.

#### 1 Load a disc or connect a USB mass storage class device and insert a recordable cassette.

#### 2 Check the tape running direction and Reverse Mode settings on the display.

- See step 2 of “Recording onto a Tape” on page 29.

#### 3 Select the source you want to record.

When recording from the disc:

- Select the disc number you want to start recording from.

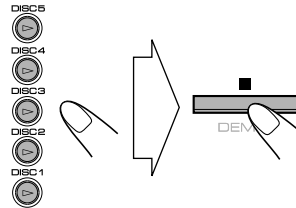

When recording from the USB mass storage class device:

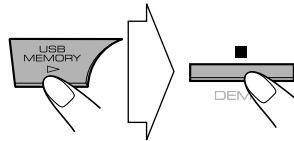

#### For recording desired tracks/files from discs:

You can program tracks/files to record in your preferred order.

Select Program Play (and make a program; see page 20) before starting playback.

#### 4 Start recording.



Playback and recording start from the first track/file.

- The System automatically creates 4-second blank between the tunes recorded on the tapes.
- When either playback or recording ends, both playback and recording stop at the same time.

### To record only your favorite track/file —One Track Recording

You can specify track/file to record on the tape while listening to a disc/USB mass storage class device.

- This function is available only for CD/VCD/SVCD and Audio files (without PBC for SVCD/VCD).
- Not available with Program Play and Random Play.

#### While the track/file you want to record is playing...



Playback returns to the beginning of that track/file and the track/file is recorded on the tape. After recording, both playback and recording stop.

#### To cancel while recording

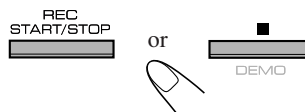

# Enjoying Karaoke

## Remote control

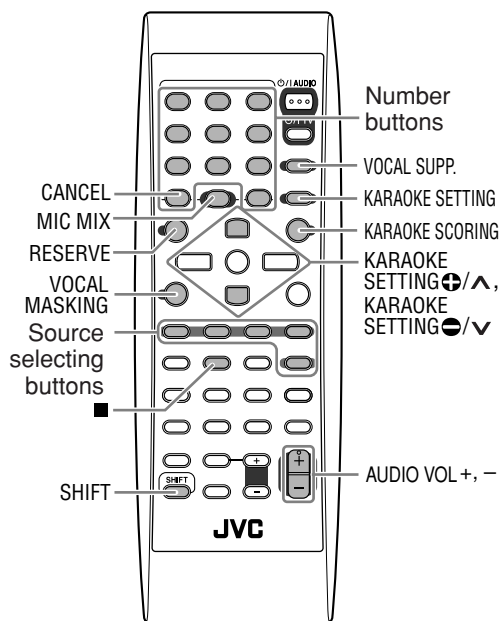

## Main unit

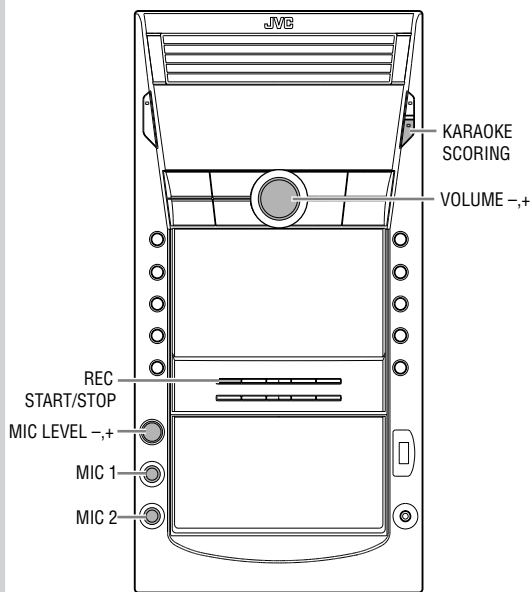

DO NOT keep the microphones connected while they are not in use.

## IMPORTANT

- Always set MIC LEVEL to “0” when connecting or disconnecting the microphone.
- MIC LEVEL adjustment is valid for both microphones connected to the MIC 1 and MIC 2 jacks.
- MIC LEVEL and MICVOL mentioned in this Instruction Book carry the same meaning.

## Singing Along (Karaoke)

You can enjoy singing along (Karaoke) by using one or two microphones.

- By pressing REC START/STOP, you can record your singing-along.

### 1 Turn MIC LEVEL to “0”.



### 2 Connect the microphone(s) (not supplied) to the MIC 1 and/or MIC 2 jack.

Mic Mixing will be automatically activated.



### 3 Start playing a source—“TUNER FM,” “TUNER AM,” “DVD/CD,” “USB,” “TAPE-A,” “TAPE-B” or “AUX.”

- For Karaoke discs: Select a desired audio channel. See “Selecting the Audio Track” on page 17.

### 4 Sing into the microphone.

### 5 Adjust the MIC LEVEL and VOLUME.

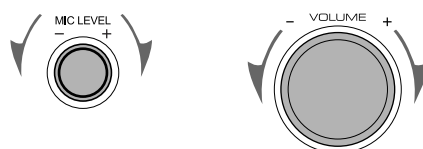

To use microphone only, select “DVD/CD” or “USB” in step 3, but do not start playback.

### To cancel the Mic Mixing

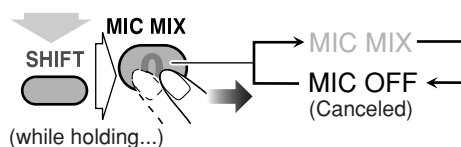

## Adjusting the Sound Track for Karaoke



You can adjust the sound track for Karaoke.

**For stereo (2-channel) source:** By selecting VOCAL MASK, you can reduce the lead vocal—Vocal Masking.

**For Karaoke disc:** By selecting L CHANNEL or R CHANNEL, you can select the audio channel to play. While Mic Mixing is activated...

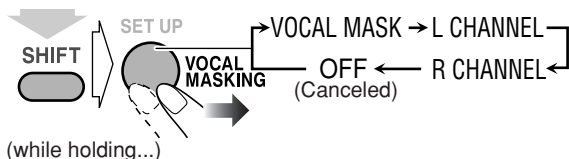

<b>VOCAL MASK</b>	Reduce the vocal from stereo (2-channel) source.
<b>L CHANNEL</b>	Reproduces only the left audio channel.
<b>R CHANNEL</b>	Reproduces only the right audio channel.

To return to normal playback, select “OFF.”

### To return to normal playback temporarily

This function allows you to recover the lead vocal temporarily for your reference.

While Vocal Masking, L CHANNEL or R CHANNEL is activated...



The vocal or stereo effect will be restored temporarily.

To return to Vocal Masking, L CHANNEL or R CHANNEL, press the same button again.

## Scoring Your Karaoke Skill



This System can score your Karaoke skill by comparing your singing along with the vocal on the playback source.

- This function is available only for disc/USB mass storage class device playback.
- It is recommended to select the soundtrack as follows (see page 17):

**For Karaoke DVD Video:** Select a sound track with vocal.

**For Karaoke SVCD/VCD:** Select “ST,” “ST1” or “ST2.”

- After selecting a sound track, select VOCAL MASK, L CHANNEL or R CHANNEL using the VOCAL MASKING button (see above).

### 1 Select “DVD/CD” or “USB” as the source.



### 2 Connect the microphone(s) (not supplied) to the MIC 1 and/or MIC 2 jack.

Mic Mixing will be activated.

- If a microphone is already connected and Mic Mixing is not activated, use the MIC MIX button to reactivate Mic Mixing (see page 31).

### 3 Activate Karaoke Scoring.

“KSCORE ON” appears on the display.

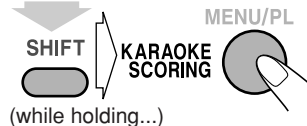

- During Karaoke Scoring, scoring will start when playback is started.
- To cancel Karaoke Scoring before playback, press the same button again. “KSCORE OFF” appears on the display.

### 4 Start playback and sing into the microphone.

Karaoke Scoring starts.

- Adjust echo level and key if you want. (See “To apply an echo to your voice” and “To adjust the key” on page 33.)
- When you press ◀◀ or ▶▶, Karaoke Scoring is canceled and restarts from the selected track/file.

After the song ends, playback stops and the score board appears on the TV screen with fanfare.

Ex.:

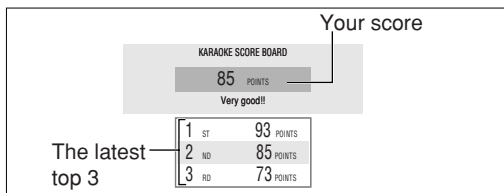

- When you press ■, Karaoke Scoring is canceled. When playback starts again, Karaoke Scoring restarts.
- If you do not sing for about 2 minutes after Karaoke Scoring starts, Karaoke Scoring is canceled. If you sing a song too quietly for the System to detect your voice for about 2 minutes after Karaoke Scoring starts, Karaoke Scoring may be canceled.
- To obtain a correct scoring result, it is recommended to sing the song completely. If the singing time is less than 3 minutes, the scoring result may be “0” or incorrect.

**To stop the playback in the middle of the song,** press ■. Karaoke Scoring is not canceled and your singing along is scored until that time.

**To activate Karaoke Scoring in the middle of the song,** press KARAOKE SCORING. “SCORING” and “START” appear on the display, then scoring starts from that point.

**To deactivate Karaoke Scoring in the same song during playback,** press KARAOKE SCORING. “SCORING” and “CANCEL” appear on the display.

- Once you deactivate Karaoke Scoring in the same song during playback, pressing KARAOKE SCORING switches “KSCORE ON” and “KSCORE OFF” alternately.

- When you reactivate Karaoke Scoring in the same song during playback and “KSCORE ON” is selected, scoring starts from the next track.

## Changing the Karaoke Setting

You can change five settings for Karaoke.

- To escape from Karaoke setting, wait for several seconds after the setting is done.

### To apply an echo to your voice

1

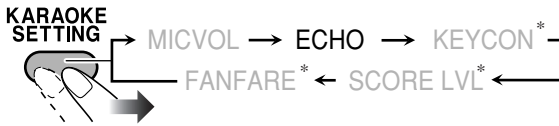

\* Appears only when “DVD/CD” or “USB” is selected as the source with Mic Mixing activated.

### 2 Adjust the echo level.

KARAOKE SETTING ⊕

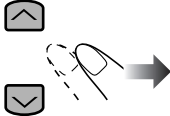

KARAOKE SETTING ⊖

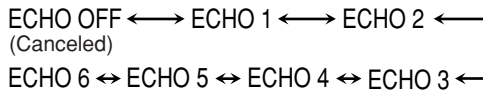

- As the number increases, echo level also increases.

### To adjust the key

- This function is available for disc/USB mass storage class device playback.
- This function is available only for CD/VCD/SVCD/DVD Video and Audio files.
- Key adjustment will be canceled when you deactivate Mic Mixing, or select another disc, track or file.

#### 1 Select “DVD/CD” or “USB” as the source.

#### 2 Connect the microphone(s) (not supplied) to the MIC 1 and/or MIC 2 jack.

Mic Mixing will be automatically activated.

- If a microphone is already connected and Mic Mixing is not activated, use the MIC MIX button to reactivate Mic Mixing (see page 31).

#### 3 Start playback, then...



#### 4 Adjust the key.

KARAOKE SETTING ⊕

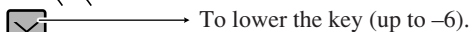
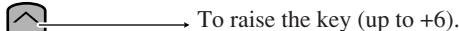

KARAOKE SETTING ⊖

To return to normal key, select “0.”

### To change the scoring level

You can change the scoring level of Karaoke Scoring.

- This function is available only for disc/USB mass storage class device playback.

#### 1 Select “DVD/CD” or “USB” as the source.

#### 2 Connect the microphone(s) (not supplied) to the MIC 1 and/or MIC 2 jack.

Mic Mixing will be automatically activated.

- If a microphone is already connected and Mic Mixing is not activated, use the MIC MIX button to reactivate Mic Mixing (see page 31).

3



#### 4 Select the scoring level setting.

KARAOKE SETTING ⊕

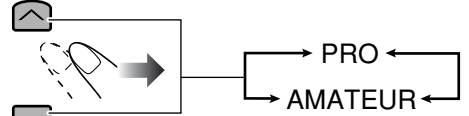

KARAOKE SETTING ⊖

PRO Scoring level is strict.

AMATEUR Scoring level is lenient.

### To turn on/off the fanfare

You can turn the fanfare on or off for Karaoke Scoring.

- This function is available only for disc/USB mass storage class device playback.

1

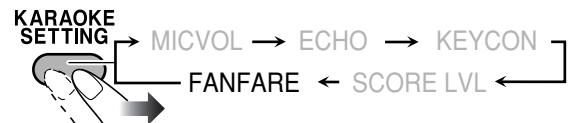

#### 2 Select the fanfare setting.

KARAOKE SETTING ⊕

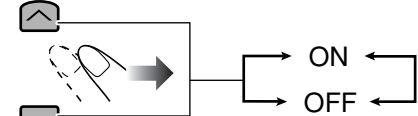

KARAOKE SETTING ⊖

(Canceled)

## To change the mic volume



1

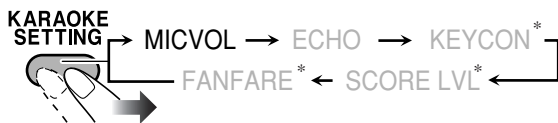

\* Appears only when “DVD/CD” or “USB” is selected as the source with Mic Mixing activated.

2 Select the volume level.

KARAOKE SETTING  $\oplus$



KARAOKE SETTING  $\ominus$

• The mic volume level can be adjusted in 16 steps (MICVOL 0 – 15).

## Reserving Karaoke Songs

### —Karaoke Program Play

INFO

You can determine the playback order of the titles, chapters, tracks or files on the disc player. You can program up to 12 steps.

• This function is not available for files in a USB mass storage class device.

1 Select “DVD/CD” as the source.

2 Turn the MIC LEVEL to “0”.



3 Connect the microphone(s) (not supplied) to the MIC1 or MIC2 jack.

Mic Mixing will be automatically activated.

• If a microphone is already connected and Mic Mixing is not activated, use the MIC MIX button to reactivate Mic Mixing (see page 31).

4 Activate Karaoke Program Play.

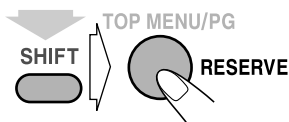

(while holding...)

No	Disc	Gr/Tt	Tr/Chap
1	■		
2			
3			
4			
5			

On the TV screen

• The PROGRAM indicator flashes during this mode.

5 Select songs you want for Karaoke Program Play.

Press the number buttons to select a song in the following order.

- ① Select a disc.
- ② Select a title/group.
- ③ Select a chapter/track/file.

① ② ③

④ ⑤ ⑥

⑦ ⑧ ⑨

⑩ 0  $\leq 10$

• To select a number, see “How to select a number” on page 8.

• To cancel the procedure, press RESERVE while holding SHIFT. The PROGRAM indicator disappears.

6 Start playback.

DVD/CD

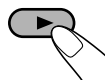

Karaoke Reserve screen disappears and playback starts in the order you have programmed.

• For the Karaoke Program Play with Karaoke

Scoring: Each time the song ends, playback stops and the score board appears. Press DVD/CD  $\blacktriangleright$  to start playback of the next track.

7 Sing into the microphone.

8 Adjust the MIC LEVEL and VOLUME.

## To check the programmed contents



(while holding...)

Karaoke Reserve screen appears.

• You cannot display Karaoke Reserve screen while Karaoke Scoring is in use.

## To modify the program

While Karaoke Reserve screen is shown on the TV...

### To erase the unwanted step:

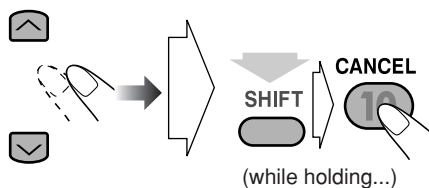

(while holding...)

To erase the entire program, repeat the procedure.

### To add steps in the program:

Repeat step 5.

# Timer Operations

## Remote control

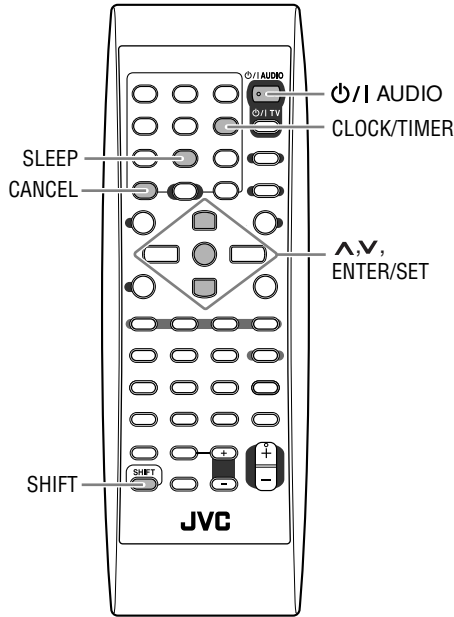

**1** Select one of the timer setting modes—ON for Recording Timer or Daily Timer.

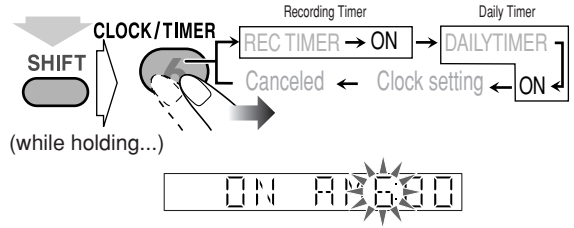

**2** Make the timer setting as you want.

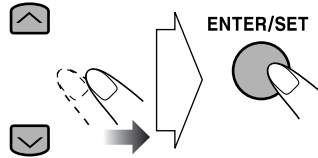

Repeat the procedure for the following setting until finished.

- ① Set the hour then minute for on-time.
- ② Set the hour then minute for off-time.
- ③ For Recording Timer: Select the playback source—"TUNER-FM," "TUNER-AM" or "AUX."

For Daily Timer: Select the playback source—"TUNER-FM," "TUNER-AM," "DISC," "USB," "TAPE-A," "TAPE-B" or "AUX."



EX.: When "TUNER-FM" is selected.

- When you select "AUX" as the source, you also need to set the timer of the external component.
- ④ Select an item you want to play or record as follows.
  - "TUNER-FM" and "TUNER-AM": Preset station.
  - "DISC": Disc, group/title and track/file/chapter.
  - "USB": Group and file.
- ⑤ Select the volume level.
  - You can select the volume level ("VOLUME 0" – "VOLUME 30" and "VOLUME --"). If you select "VOLUME --," the volume is set to the last level when the System has been turned off.

After making the timer setting, "SET OK" appears and your setting items appear on the display one after another.

## Setting the Timer

Remote ONLY

INFO

Using Daily Timer, you can wake up with your favorite song. On the other hand, with Recording Timer, you can make a tape of a radio broadcast automatically.

- You cannot activate Daily Timer and Recording Timer at the same time. (Activating either timer deactivates the other timer.)
- To correct a misentry during the process, press CANCEL while holding SHIFT. You can return to the previous step.



**3 Turn off the System (on standby) if you have set the timer with the System turned on.**

⏻/I AUDIO



**How Recording Timer works**

When Recording Timer has been set, the timer indicator (⏻) and the REC indicator are lit on the display. Recording Timer works only once.

- Recording Timer starts working only when the System is turned off (on standby).

**When the on-time comes**

The System turns on, tunes in to the specified station, sets the volume level to the preset level, and starts recording.

**When the off-time comes**

- The System stops recording, and turns off (on standby).
- The timer setting remains in memory until you change it.

**How Daily Timer works**

Once the Daily Timer has been set, the timer indicator (⏻) and DAILY indicator are lit on the display. Daily Timer is activated at the same time everyday until the timer is turned off manually (see below).

- Daily Timer starts working only when the System is turned off (on standby).

**When the on-time comes**

The System turns on, tunes in to the specified station or starts playing the specified source, and sets the volume level gradually to the preset level after about 30 seconds.

**When the off-time comes**

- The System stops playback, and turns off (standby).
- The timer setting remains in memory until you change it.

**To turn off the Timer after the setting is done**

You can turn off the timer after it has been set.

- Since Daily Timer works at the same time everyday, you may need to cancel it on some particular days.

**1 Select the timer (REC TIMER or DAILYTIMER) you want to cancel.**

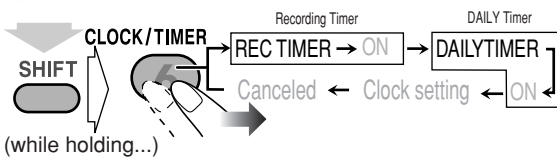

**2 Turn off the selected timer.**

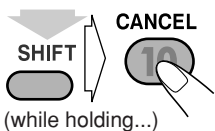

- The timer indicator (⏻) goes off.

To turn on the timer again, repeat step 1 and press ENTER/SET in step 2.

**Turning Off the Power Automatically**



With Sleep Timer, you can fall asleep while listening to music.

**1 Specify the time (in minutes).**

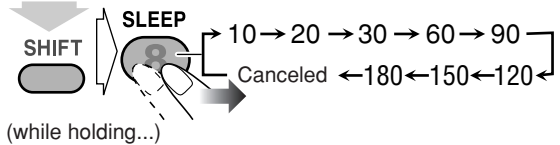

**2 Wait until the set time disappears.**

To check the time remaining until the shut-off time

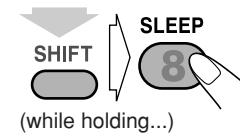

- If you press the button repeatedly, you can change the shut-off time.

**Timer Priority**

If Timer settings overlap, the timers work as described below.

- Sleep Timer has priority over the Recording Timer and Daily Timer.

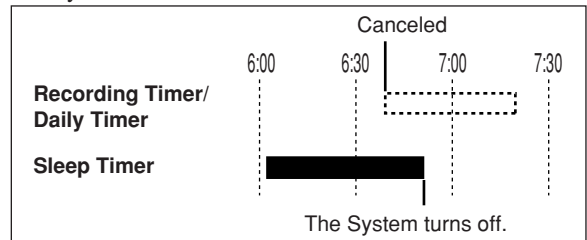

- In this case, Recording Timer/Daily Timer does not work.

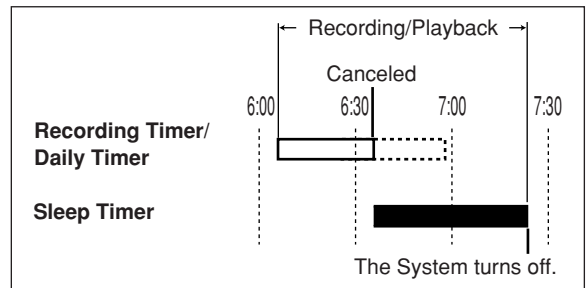

- In this case, Recording Timer/Daily Timer is canceled. (If Sleep Timer shuts off the System earlier than the off time you have set for Recording Timer, recording stops when Sleep Timer shuts off the System.)

# Setup Menu Operations

## Remote Control

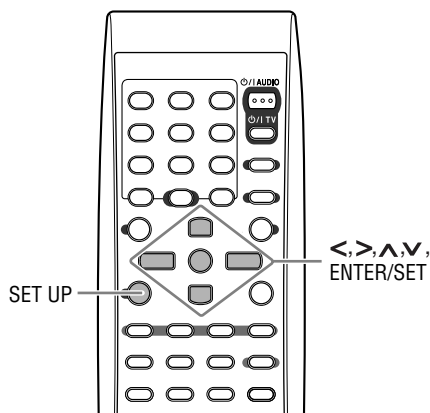

## Basic Procedure

You can change the setting of the System.

- The setup menu can be used only when “DVD/CD” or “USB” is selected as the source.

### 1 Press SET UP while playback is stopped.

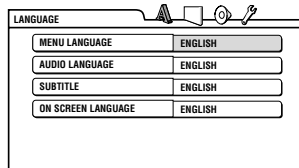

### 2 Press > (or <) to select the menu.

### 3 Press v (or ^) to select the item.

### 4 Press ENTER/SET.

### 5 Press v (or ^) to select the options, then press ENTER/SET.

To erase a preference display, press SET UP.

## LANGUAGE menu

Item	Contents
<b>MENU LANGUAGE</b>	You can select the initial menu language of DVD Video (see page 46).
<b>AUDIO LANGUAGE</b>	You can select the initial audio language of DVD Video (see page 46).
<b>SUBTITLE</b>	You can select the initial subtitle language of DVD Video (see page 46).
<b>ON SCREEN LANGUAGE</b>	You can select “ENGLISH,” “SPANISH,” or “FRENCH” as the on-screen language.

## PICTURE menu

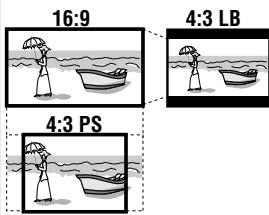
Item	Contents
<b>MONITOR TYPE</b> 	You can select the monitor type to match your TV when you play back picture recorded for wide-screen televisions. <b>16:9 NORMAL (Wide television screen):</b> Select this when the aspect ratio of your wide TV is fixed to 16:9. <b>16:9 AUTO (Wide television screen):</b> Select this when your TV is an ordinary wide TV. <b>4:3 LB (Letter Box conversion):</b> For a conventional (4:3) TV. Displays a wide-screen picture to fit the width of the TV screen keeping the aspect ratio. <b>4:3 PS (Pan Scan conversion):</b> For a conventional (4:3) TV. The picture is zoomed in to fill the screen vertically and the left and right sides of the picture are cut off.
<b>PICTURE SOURCE</b>	You can obtain optimal picture quality by selecting the type of the video source. <b>AUTO:</b> Normally, select this option. The System recognizes the picture type (film or video source) of the current picture according to its information. <b>FILM:</b> For a film source picture. <b>VIDEO:</b> For a video source picture.
<b>SCREEN SAVER</b>	You can set the screen saver function to <b>ON</b> or <b>OFF</b> . <b>ON:</b> The on-screen display becomes dark when no operation is done for about 5 minutes. <b>OFF:</b> To cancel the screen saver.
<b>FILE TYPE</b>	You can select a file type to play. <b>AUDIO:</b> To play Audio files. (MP3/WMA/WAV files.) <b>STILL PICTURE:</b> To play Still Picture files. (JPEG file.) <b>VIDEO:</b> To play Video files. (MPEG-1/MPEG-2/ASF files.)



## AUDIO menu

Item	Contents
<b>DIGITAL AUDIO OUTPUT</b>	Set this item correctly when using the OPTICAL DIGITAL OUTPUT terminal on the rear. <b>PCM ONLY:</b> When connecting to audio equipment which is compatible with only linear PCM signals. <b>DOLBY DIGITAL/PCM:</b> When connecting to a Dolby Digital decoder or an amplifier with built-in Dolby Digital decoder. <b>STREAM/PCM:</b> When connecting to a DTS/MPEG Audio decoder or an amplifier with built-in DTS/MPEG Audio decoder.
<b>DOWN MIX</b>	This setting is effective for digital audio output if “DIGITAL AUDIO OUTPUT” is set to “PCM ONLY.” <b>DOLBY SURROUND:</b> Select this when connecting a surround decoder. <b>STEREO:</b> Select this when connecting a stereo receiver, MD player, TV, etc.
<b>D. RANGE COMPRESSION</b>	You can enjoy a powerful sound at a low volume level while playing Dolby Digital software. <b>AUTO:</b> Select to apply the compression only to multi-channel encoded audio (except for 1-channel and 2-channel sources.) <b>ON:</b> Select this to always apply the compression.



## OTHERS menu

Item	Contents
<b>RESUME</b>	You can select Resume. <b>ON:</b> The System resumes playback from the position where playback has been stopped (not applicable for CD). <b>OFF:</b> Resume is deactivated.
<b>ON SCREEN GUIDE</b>	Activate or deactivate the on-screen guide. <b>ON:</b> Activate the on-screen guide. <b>OFF:</b> Deactivate the on-screen guide.

# Operating the TV

## Remote control

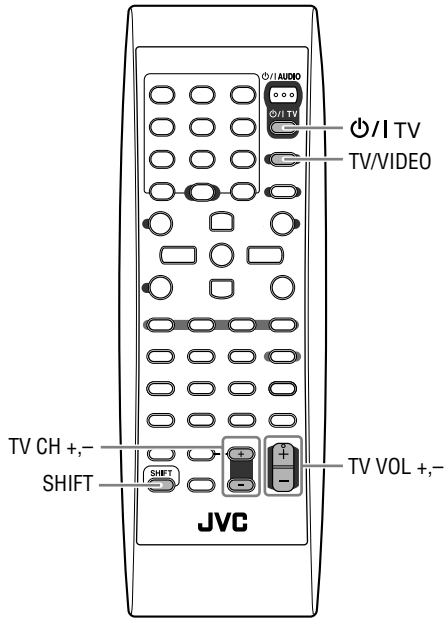

You can operate JVC's TV using the remote control supplied for this System.

To turn on or off the TV:	To select the input mode (either TV or VIDEO):
<p><b>Power/TV</b></p>	<p><b>SHIFT</b> (while holding...)</p> <p><b>TV/VIDEO</b> VOCAL SUPP.</p>
To adjust TV volume:	
<p><b>SHIFT</b> (while holding...)</p> <p><b>TV VOL</b></p>	
To select the TV channel:	
<p><b>SHIFT</b> (while holding...)</p> <p><b>TV CH</b></p>	

# Additional Information

## Learning More about This System ● ● ●

### Connections (see pages 3 to 6)

#### Changing the Color System:

- If you play back an NTSC disc/file with the color system set to “PAL,” the disc/file will be reproduced using “PAL 60” format; however, if the TV does not support this format, the screen may not display properly.
- If you play back a PAL disc/file with the color system set to “NTSC,” you can watch the playback pictures, but the following symptoms may occur:
  - The items on the menu will be blurred, and be shown slightly shifted when highlighted.
  - The aspect ratio of the picture may differ from the original aspect ratio.
  - The picture movement is not smooth.

### Daily Operations—Playback (see pages 8 to 12)

#### Listening to the Radio:

- If you store a new station into an occupied preset number, the previously stored station in that number will be erased.
- When you unplug the AC power cord or if a power failure occurs, the preset stations may be erased in a few days. If this happens, preset the stations again.

#### Playing Back a Disc/USB Mass Storage Class Device:

- When you change the source to “DVD/CD” or “USB,” it may take a while to activate the source.
- While the System is reading a disc, the source may not change to “USB” correctly. In this case, press ■, then reactivate “USB” as the source.
- On some discs/files, the actual operations may be different from what is explained in this manual, due to the programming and disc structure; such differences are not a malfunction of this System.
- For playback of files in the USB mass storage class device...
  - When connecting a USB mass storage class device, refer also to its manual.
  - Connect one USB mass storage class device to the System at a time. Do not use a USB hub.
  - You cannot charge any other USB device through the  (USB MEMORY) terminal of this System.
  - While playing back a file in a USB mass storage class device, do not disconnect the device. It may cause a malfunction of both the System and the device.
  - JVC bears no responsibility for any loss of data in the USB mass storage class device while using this System.
  - When connecting with a USB cable, use the cable whose length is less than 1 m (3.3 ft).
  - This System is compatible with USB 2.0 Full Speed.
- You can play back the following types of files in a USB mass storage class device (maximum data transfer rate: 2 Mbps):
  - Audio: MP3, WMA, WAV
  - Still picture: JPEG
  - Video: MPEG-1, MPEG-2, ASF
  - This System may not play back some files even though their formats are listed above.
- You cannot play back a file larger than 2 Gigabyte.
- When playing a file which has a high transfer rate, frames or sounds may be dropped during playback.
- This System cannot recognize a USB mass storage class device whose rating is other than 5 V and exceeds 500 mA.
- This System may not play back some USB mass storage class devices and does not support DRM (Digital Rights Management).
- It will take some time to start up a Digital Audio Player (DAP) larger than 1 Gigabyte.
- You cannot send any data to your USB mass storage class device from this System.
- For MP3/WMA/WAV playback...
  - MP3/WMA/WAV discs require a longer readout time than regular CDs. (It depends on the complexity of the group/file configuration.)
  - Some MP3/WMA/WAV files cannot be played back and will be skipped. This results from their recording processes and conditions.
  - When making MP3/WMA/WAV discs, use ISO 9660 Level 1 or Level 2 for the disc format.
  - This System can play back MP3/WMA/WAV files with the extension code <.mp3>, <.wma> or <.wav> (regardless of the letter case—upper/lower).
  - It is recommended that you make each MP3/WMA/WAV files at the following conditions:
    - MP3/WMA: At a sampling rate of 44.1 kHz and bit rate of 128 kbps.
    - WAV: 44.1 kHz/16 bit Linear PCM.
    - This System cannot play back files made at bit rate of less than 64 kbps.
- For DVD-VR playback...
  - **Original Program:** The System can play back the original picture in the recorded order.
  - **Play List:** The System can play back the play list edited by the recording equipment.
  - For details about DVD-VR format and play list, refer to the manual of the recording equipment.

- For JPEG playback...
  - This System can play back JPEG files with the extension code <.jpg> or <.jpeg> (regardless of the letter case—upper/lower).
  - It is recommended that you record a file at 640 x 480 resolution. (If a file has been recorded at a resolution of more than 640 x 480, it will take a long time to be shown.)
  - This System can play only baseline JPEG files\*. Progressive JPEG files\* or lossless JPEG files\* cannot be played.
    - \* Baseline JPEG format: Used for digital cameras, web, etc.
    - Progressive JPEG format: Used for web.
    - Lossless JPEG format: An old type and rarely used now.
- For MPEG-1/MPEG-2 playback...
  - This System can play back MPEG-1/MPEG-2 files with the extension code <.mpg> or <.mpeg> (regardless of the letter case—upper/lower).
  - The stream format should conform to MPEG system/program stream.
  - 720 x 576 pixels (25 fps)/720 x 480 pixels (30 fps) is recommended for the highest resolution.
  - This System also supports the resolutions of 352 x 576/480 x 576/352 x 288 pixels (25 fps) and 352 x 480/480 x 480/352 x 240 pixels (30 fps).
  - The file format should be MP@ML (Main Profile at Main Level)/SP@ML (Simple profile at Main Level)/MP@LL (Main Profile at Low Level).
  - Audio streams should conform to MPEG1 Audio Layer-2 or MPEG2 Audio Layer-2.
- For ASF playback...
  - This System can play back ASF files with the extension code <.asf> (regardless of the letter case—upper/lower).
  - This System supports ASF files whose resolution is 352 x 288 pixels or less.
  - Some recorded files may not be able to played back depending on file characteristics, kind of digital still/video cameras, or recording conditions.

## Daily Operations—Sound & Other Adjustments (see pages 13 to 16)

### Reinforcing the Bass Sound:

- You cannot adjust the Active Bass level when the headphones are connected.

### Applying an Optimal Bass Sound Effect—VARIO BASS:

- If you plug in a microphone and Mic Mixing is activated, the System will automatically switches the mode to LITE.n.EASY even if the mode is set to OFF.

### Creating Your Own Sound Modes—User Mode:

- When you unplug the AC power cord or if a power failure occurs, the User Mode settings may be erased in a few days. If this happens, set the User Modes again.

### Creating 3-dimensional Sound Field—3D Phonic:

- While you use the headphones, 3D Phonic is canceled temporarily.
  - 3D Phonic is also applied to the optical digital output signals through the OPTICAL DIGITAL OUTPUT terminal.

### Setting the Clock:

- “AM 12:00” will flash on the display until you set the clock.
- The clock may gain or lose 1 to 2 minutes per month. If this happens, reset the clock.

## Unique Video Disc/File Operations (see pages 17 to 19)

### Selecting the Audio Track:

- On some disc/file, you cannot change audio languages while playing back.

### Special Picture Playback:

- During slow-motion playback, no sound will be reproduced.
- While zoomed in, the picture may look coarse.

## Advanced Playback Operations (see pages 20 to 22)

### Programming the Playing Order—Program Play:

- While programming steps...
  - Your entry will be ignored if you have tried to program an item number that does not exist on the disc (for example, selecting track 14 on a disc that only has 12 tracks).
- For SVCD/VCD/CD loaded on the other tray than the current one, the System may prompt for the group number entry as well; however, these entries will be ignored during playback.
- The programmed contents will remain until you erase it.
- While the PROGRAM indicator is on, you cannot change the disc to play. (DISC 1 – 5 on the remote control and DISC 1 – 5 ▷ on the main unit do not work.)

## On-Screen Operations (see pages 23 to 28)

### Operations Using the On-screen Bar:

- A-B Repeat is possible only within the same title or within the same track.

## Recording Operations (see pages 29 to 30)

### General:

- You cannot change the source during recording.
- There is leader tape which cannot be recorded onto at the start and the end of cassette tapes. Thus, before recording, wind the leader tape first to ensure that the recording will be made without any music part lost.
- If no cassette is inserted or a protected tape has been inserted, "NO REC" appears on the display.
- The recording level is automatically set correctly. Thus, you can make sound adjustments, without affecting the recording level.

### Recording onto a Tape:

- When using Reverse Mode for recording, start recording in the forward (▶) direction first; otherwise, recording will stop when only one side (reverse) of the tape is recorded.
- While recording onto a tape using USB/DISC REC START button, plugging in or out headphones may cause sound distortion and affect the recording.

### Synchronized Recording:

- You cannot open the disc tray while recording onto a tape using USB/DISC REC START button.
- Recording starts from the first track even if you have selected a track by using ◀◀/▶▶. To specify track(s) to record, program them (not applicable for USB mass storage class device) or use One Track Recording.
- While recording, you cannot use disc/USB mass storage class device operation buttons (except for ■).
- You cannot use Repeat Play during synchronized recording (Repeat Play will be canceled).
- USB/DISC REC START button does not work:
  - While playback is paused.
  - When Random Play mode is selected.
  - When playing back in Program Play mode.
- When the tape reaches its end in the forward direction (▶) during recording, the last song will be re-recorded at the beginning of the reverse side (◀).
- When the tape reaches its end in the reverse side (◀) during recording, recording stops even though the disc/USB mass storage class device is not entirely recorded.

## Enjoying Karaoke (see pages 31 to 34)

### General:

- While recording onto a tape, Key adjustment, Echo and Vocal Masking will be recorded. However, while recording onto a tape using USB/DISC REC START, Key adjustment will not be recorded.
- While the System is turned on, connecting a microphone automatically activates Mic Mixing and all the Karaoke related functions.

- While the System is turned off, connecting a microphone does not activate Mic Mixing and any other Karaoke related function. In this case, press MIC MIX while holding SHIFT after turning the System on.

### Adjusting the Sound Track for Karaoke:

- The Vocal Masking setting is not applied to the optical digital output signals through the OPTICAL DIGITAL OUTPUT terminal.
- On some music, Vocal Masking does not provide the correct effect.

### Scoring Your Karaoke Skill:

- You can also activate Karaoke Scoring while playing back. In this case, the scoring starts from that point. But cancel Karaoke Scoring and set Karaoke Scoring again in the same track during the playback, scoring starts from next track.
- While Karaoke Scoring is in use, you cannot deactivate Mic Mixing or use MIC MIX, RESERVE and number buttons.
- Activating Karaoke Scoring cancels Repeat Play.
- You cannot use Karaoke Scoring during Program Play, Random Play, or recording. However, you can turn Karaoke Scoring on and off by using KARAOKE SCORING button during these play modes.
- The ranking (top 3) is cleared when you turn off the System.

### Reserving Karaoke Songs—Karaoke Program Play:

- You can use RESERVE button when a microphone is plugged in. However, you can cancel Karaoke Program Play using the button even if a microphone is not plugged in. In case you reactivate Karaoke Program Play, plug in a microphone.
- If you have selected a disc tray on which a disc containing Video files or JPEG file or DVD-VR is loaded, that disc number is skipped.
- If DVD-VR or a disc containing Video files and JPEG file is loaded on the current tray, you cannot activate Karaoke Program Play.
- When the track starts playback, that track number will be erased from the Karaoke Reserve screen (the programmed contents will remain until you erase it).
- While the PROGRAM indicator is flashing, you cannot change the disc to play. (DISC 1 – 5 on the remote control and DISC 1 – 5 ▷ on the main unit do not work.)
- For some VCD, the Karaoke Scoring result may not appear at the end of the track if PBC is activated. In this case, press ■ to view your scoring result.

## Timer Operations (see pages 35 to 36)

### Setting the Timer:

- If you do not specify the preset station or track number correctly while setting a timer, the currently selected station or the first track will be played when timer is activated.
- When you unplug the AC power cord or if a power failure occurs, the timer will be canceled. You need to set the clock first, then the timer again.
- Without stopping the recording, you cannot change the source while Recording Timer is recording.
- Daily Timer will not work correctly for some DVDs.

## Setup Menu Operations (see pages 37 to 38)

### General:

- If the upper and lower parts of the menu are cut off, adjust the picture size control of the TV.

### LANGUAGE menu:

- When the language you have selected for MENU LANGUAGE, AUDIO LANGUAGE, or SUBTITLE is not recorded on a disc, the original language is used as the initial language.

### PICTURE menu—MONITOR TYPE:

- Even if “4:3 PS” is selected, the screen size may become 4:3 letter box with some disc. This depends on how they are recorded.
- When you select “16:9 NORMAL” or “16:9 AUTO” for a picture whose aspect ratio is 4:3, the picture slightly changes due to the process for converting the picture width.

### OTHERS menu—ON SCREEN GUIDE:

- The setup menu and on-screen bar will be displayed (and recorded) even though this function is set to “OFF.” Subtitles and the information for zoom-in always appear on the display regardless of this setting.

## Maintenance ●●●●●●●●

To get the best performance of the System, keep your discs, tapes and mechanism clean.

### Handling discs

- Remove the disc from its case by holding it at the edge while pressing the center hole lightly.
- Do not touch the shiny surface of the disc, or bend the disc.
- Put the disc back in its case after use to prevent warping.
- Be careful not to scratch the surface of the disc when placing it back in its case.
- Avoid exposure to direct sunlight, extreme temperatures, and moisture.

### To clean the disc:

Wipe the disc with a soft cloth in a straight line from center to edge.

## Handling cassette tapes

- If the tape is loose in its cassette, take up the slack by inserting a pencil in one of the reels and rotate it.
  - If the tape is loose, it may get stretched, cut, or caught in the cassette.
- Be careful not to touch the tape surface.
- Avoid the following places to store the tape—in dusty places, in direct sunlight or heat, in moist areas, on a TV or speaker, or near a magnet.

### To keep the best recording and playback sound quality:

- Use a cotton swab moistened with alcohol to clean the heads, capstans and pinch rollers.
- Use a head demagnetizer (available at electronics and audio shops) to demagnetize the heads (when the System is turned off).



### To protect your recording

Cassettes have two small tabs on the back to protect from unexpected erasure or re-recording.

To protect your recording, remove these tabs.

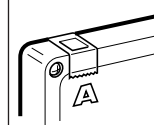

To re-record on a protected tape, cover the holes with adhesive tape.

## Cleaning the System

- Stains should be wiped off with a soft cloth. If the System is heavily stained, wipe it with a cloth soaked in water-diluted neutral detergent and wrung well, then wipe clean with a dry cloth.
- Since the System may deteriorate in quality, become damaged or get its paint peeled off, be careful about the following:
  - DO NOT wipe it with a hard cloth.
  - DO NOT wipe it forcefully.
  - DO NOT wipe it with thinner or benzine.
  - DO NOT apply any volatile substance such as insecticides to it.
  - DO NOT allow any rubber or plastic to remain in contact for a long time.



## Troubleshooting

If you are having a problem with your System, check this list for a possible solution before calling for service.

### General:

**Adjustments or settings are suddenly canceled before you finish.**

⇒ There is a time limit. Repeat procedure again.

**Operations are disabled.**

⇒ The built-in microprocessor may malfunction due to external electrical interference. Unplug the AC power cord and then plug it back in.

**Unable to operate the System from the remote control.**

⇒ The path between the remote control and the remote sensor on the System is blocked.

⇒ The batteries are exhausted.

**No sound is heard.**

⇒ Speaker connections are incorrect or loose.

⇒ Headphones are connected.

**No picture appears on the screen.**

⇒ The video cord connections are incorrect or loose.

**No picture is displayed on the TV screen, the picture is blurred, or the picture is divided into two parts.**

⇒ Incorrect color system is selected (see page 6).

**The left and right edges of the picture are missing on the screen.**

⇒ Select “4:3 LB” for “MONITOR TYPE” (see page 37).

### Radio Operations:

**Hard to hear broadcasts because of noise.**

⇒ Antennas connections are incorrect or loose.

⇒ The AM loop antenna is too close to the System.

⇒ The FM antenna is not properly extended and positioned.

### Disc/file Operations:

**The disc does not play.**

⇒ You have inserted a DVD Video whose Region Code is not “1.” (“REGION ERR” appears on the display.)

⇒ The disc is placed upside down. Place the disc with the label side up.

**ID3 Tag on an MP3 disc cannot be shown.**

⇒ There are two types of ID3 Tag—Version 1 and Version 2. This System can only show ID3 Tag Version 1.

**Groups and files are not played back as you expect.**

⇒ The playing order is determined when the files were recorded. It depends on the application.

**AV files are not played back.**

⇒ The disc or USB mass storage class device includes different types of files (Audio file, Video file and Still picture file). In this case, you can play back the files selected only by the “FILE TYPE” setting (see page 37).

⇒ You have changed the “FILE TYPE” setting after the System read the disc or the USB mass storage class device. In this case, reload the disc or disconnect the USB mass storage class device and connect it again.

**The disc sound is discontinuous.**

⇒ The disc is scratched or dirty.

**The playback sounds strange.**

⇒ Cancel Vocal Masking (see page 32).

⇒ Cancel Key adjustment (see page 33).

**No subtitle appears on the TV screen though you have selected the initial subtitle language.**

⇒ Some discs are programmed to always display no subtitle initially. If this happens, press SUB TITLE after starting play (see page 18).

**Audio language is different from the one you have selected as the initial audio language.**

⇒ Some discs/files are programmed to always use the original language initially. If this happens, press AUDIO/MPX after starting play (see page 17).

**The disc tray does not open or close.**

⇒ The AC power cord is not plugged in.

⇒ Child Lock is in use. “LOCKED” appears on the display window (see page 22).

⇒ Program Play is in use. Cancel Program Play (see page 21).

### Tape Operations:

**The cassette holder cannot be opened.**

⇒ Power supply from the AC power cord has been cut off while the tape was running. Turn on the System.

### Recording Operations:

**“CANNOT REC” appears on the display.**

⇒ The System cannot perform recording.

**Impossible to record.**

⇒ Small tabs on the back of the cassette are removed. Cover the holes with adhesive tape.

⇒ Karaoke Scoring is in use. Cancel the Karaoke Scoring (see page 32).

### Karaoke Operations:

**Karaoke function cannot be activated.**

⇒ Ensure at least 1 microphone is connected and Mic Mixing is activated. If a microphone is not connected, you cannot activate Mic Mixing and any other Karaoke related function.

**Karaoke Scoring function cannot be activated.**

⇒ You cannot use Karaoke Scoring while recording, or while the disc menu for DVD Video/SVCD/VCD is shown on the TV screen.

**Scoring result seems wrong (or “-” appears).**

⇒ The time of the playback and singing along are too short for Karaoke Scoring. It is recommended to sing more than 3 minutes to obtain a correct scoring result.

⇒ No sound from the microphone or the input level (MIC LEVEL) is too low.

⇒ You have sung too quietly.

### Timer Operations:

**Daily Timer or Recording Timer does not work.**

⇒ The System has been turned on when the on-time comes. Timer starts working only when the System is turned off.

## OPTICAL DIGITAL OUTPUT Signals

DIGITAL AUDIO OUTPUT Playback disc/file	Output Signals		
	STREAM/PCM	DOLBY DIGITAL/PCM	PCM ONLY
<b>DVD Video</b>			
with 48 kHz, 16/20/24 bit Linear PCM	48 kHz, 16 bit Linear PCM*		
with 96 kHz, Linear PCM	48 kHz, 16 bit Linear PCM		
with Dolby Digital	Dolby Digital bitstream		48 kHz, 16 bit Linear PCM
with DTS	DTS bitstream	48 kHz, 16 bit Linear PCM	
<b>DVD-R/-RW in DVD-VR format</b>			
with 48 kHz, 16/20/24 bit Linear PCM	48 kHz, 16 bit Linear PCM*		
with Dolby Digital	Dolby Digital bitstream		48 kHz, 16 bit Linear PCM
<b>SVCD, VCD, CD</b>	44.1 kHz, 16 bit Linear PCM/48 kHz, 16 bit Linear PCM		
<b>CD with DTS</b>	DTS bitstream	44.1 kHz, 16 bit Linear PCM	
<b>MP3/WMA/WAV/MPEG-1/ MPEG-2 disc/file</b>	32 kHz/44.1 kHz/48 kHz, 16 bit Linear PCM		
<b>ASF disc/file</b>	32 kHz, 16 bit Linear PCM		

\* While playing some DVDs, digital signals may be emitted at 20 bits or 24 bits (at their original bit rate) through the OPTICAL DIGITAL OUTPUT terminal if the discs are not copy-protected.

## Language Code List

<b>AA</b> Afar	<b>FA</b> Persian	<b>KM</b> Cambodian	<b>OC</b> Occitan	<b>SV</b> Swedish
<b>AB</b> Abkhazian	<b>FI</b> Finnish	<b>KN</b> Kannada	<b>OM</b> (Afan) Oromo	<b>SW</b> Swahili
<b>AF</b> Afrikaans	<b>FJ</b> Fiji	<b>KO</b> Korean (KOR)	<b>OR</b> Oriya	<b>TA</b> Tamil
<b>AM</b> Ameharic	<b>FO</b> Faroese	<b>KS</b> Kashmiri	<b>PA</b> Panjabi	<b>TE</b> Telugu
<b>AR</b> Arabic	<b>FY</b> Frisian	<b>KU</b> Kurdish	<b>PS</b> Pashto, Pushto	<b>TG</b> Tajik
<b>AS</b> Assamese	<b>GA</b> Irish	<b>KY</b> Kirghiz	<b>PT</b> Portuguese	<b>TH</b> Thai
<b>AY</b> Aymara	<b>GD</b> Scots Gaelic	<b>LA</b> Latin	<b>QU</b> Quechua	<b>TI</b> Tigrinya
<b>AZ</b> Azerbaijani	<b>GL</b> Galician	<b>LN</b> Lingala	<b>RM</b> Rhaeto-Romance	<b>TK</b> Turkmen
<b>BA</b> Bashkir	<b>GN</b> Guarani	<b>LO</b> Laothian	<b>RN</b> Kirundi	<b>TL</b> Tagalog
<b>BE</b> Byelorussian	<b>GU</b> Gujarati	<b>LT</b> Lithuanian	<b>RO</b> Rumanian	<b>TN</b> Setswana
<b>BG</b> Bulgarian	<b>HA</b> Hausa	<b>LV</b> Latvian, Lettish	<b>RW</b> Kinyarwanda	<b>TO</b> Tonga
<b>BH</b> Bihari	<b>HI</b> Hindi	<b>MG</b> Malagasy	<b>SA</b> Sanskrit	<b>TR</b> Turkish
<b>BI</b> Bislama	<b>HR</b> Croatian	<b>MI</b> Maori	<b>SD</b> Sindhi	<b>TS</b> Tsonga
<b>BN</b> Bengali, Bangla	<b>HY</b> Armenian	<b>MK</b> Macedonian	<b>SG</b> Sangho	<b>TT</b> Tatar
<b>BO</b> Tibetan	<b>IA</b> Interlingua	<b>ML</b> Malayalam	<b>SH</b> Serbo-Croatian	<b>TW</b> Twi
<b>BR</b> Breton	<b>IE</b> Interlingue	<b>MN</b> Mongolian	<b>SI</b> Singhalese	<b>UK</b> Ukrainian
<b>CA</b> Catalan	<b>IK</b> Inupiak	<b>MO</b> Moldavian	<b>SL</b> Slovenian	<b>UR</b> Urdu
<b>CO</b> Corsican	<b>IN</b> Indonesian	<b>MR</b> Marathi	<b>SM</b> Samoan	<b>UZ</b> Uzbek
<b>CY</b> Welsh	<b>IS</b> Icelandic	<b>MS</b> Malay (MAY)	<b>SN</b> Shona	<b>VI</b> Vietnamese
<b>DA</b> Danish	<b>IW</b> Hebrew	<b>MT</b> Maltese	<b>SO</b> Somali	<b>VO</b> Volapuk
<b>DZ</b> Bhutani	<b>JI</b> Yiddish	<b>MY</b> Burmese	<b>SQ</b> Albanian	<b>WO</b> Wolof
<b>EL</b> Greek	<b>JW</b> Javanese	<b>NA</b> Nauru	<b>SR</b> Serbian	<b>XH</b> Xhosa
<b>EO</b> Esperanto	<b>KA</b> Georgian	<b>NE</b> Nepali	<b>SS</b> Siswati	<b>YO</b> Yoruba
<b>ET</b> Estonian	<b>KK</b> Kazakh	<b>NL</b> Dutch	<b>ST</b> Sesotho	<b>ZU</b> Zulu
<b>EU</b> Basque	<b>KL</b> Greenlandic	<b>NO</b> Norwegian	<b>SU</b> Sundanese	

## Specifications

### Amplifier section—CA-DXJ21

Output Power:

MAIN SPEAKERS:

105 W per channel, min. RMS, driven into 6  $\Omega$  at 1 kHz with no more than 10% total harmonic distortion.

SUBWOOFER: 105 W, min. RMS, driven into

6  $\Omega$  at 63 Hz with no more than 10% total harmonic distortion.

Digital output:

OPTICAL DIGITAL OUTPUT:

-21 dBm to -15 dBm (660 nm  $\pm$ 30 nm)

Digital input:  (USB MEMORY)

Audio input sensitivity/Impedance

(Measured at 1 kHz, with tape recording signal 300 mV)

AUX: 400 mV/47 k $\Omega$

MIC1/2: 3.0 mV/50 k $\Omega$

VIDEO OUT:

Color system: NTSC/PAL

VIDEO (composite): 1 V(p-p)/75  $\Omega$

S-VIDEO: Y (luminance) 1 V(p-p)/75  $\Omega$

C (chrominance, burst)

NTSC 0.286 V(p-p)/75  $\Omega$

PAL 0.3 V(p-p)/75  $\Omega$

Speaker Terminals: 6  $\Omega$  - 16  $\Omega$  (main speakers/subwoofer)

### Tuner section

FM tuning range: 87.5 MHz - 108.0 MHz

AM (MW) tuning range: 530 kHz - 1 710 kHz

### Disc/File player section

Playable disc:

DVD Video/CD/VCD/SVCD  
CD-R/CD-RW (MP3/WMA/WAV/  
JPEG/MPEG-1/MPEG-2/ASF format)  
DVD-R/-RW (DVD-VR/DVD-video/  
MP3/WMA/WAV/JPEG/MPEG-1/  
MPEG-2/ASF format)  
+R/+RW (DVD-video/MP3/WMA/  
WAV/JPEG/MPEG-1/MPEG-2/ASF  
format)  
DVD-ROM (DVD-video/MP3/WMA/  
WAV/JPEG/MPEG-1/MPEG-2/ASF  
format)

Playable file: MP3/WMA/WAV/JPEG/MPEG-1/  
MPEG-2/ASF format

Dynamic range: 80 dB

Horizontal resolution: 500 lines

Wow and flutter: Immeasurable

### USB storage section

USB specification: Compatible with USB 2.0 Full Speed

Compatible device: Mass storage class

Compatible file system: FAT 16, FAT 32

Bus power supply: DC 5 V  500 mA

### Cassette deck section

Frequency response

Normal (type I): 50 Hz - 14 000 Hz

Wow and flutter: 0.15% (WRMS)

### Subwoofer (SP-DXJ21W)

Type:

1-Way Bass-Reflex Type

(Magnetically Shielded Type)

Speaker:

16.0 cm (6-5/16 inches) cone x 1

Power Handling Capacity: 120 W

Impedance: 6  $\Omega$

Frequency Range: 45 Hz to 5 000 Hz

Sound Pressure Level: 88 dB/W•m

Dimensions (W  $\times$  H  $\times$  D):

205 mm  $\times$  370 mm  $\times$  236 mm

(8-1/8 inches  $\times$  14-5/8 inches  $\times$  9-5/16 inches)

Mass:

3.5 kg (7.8 lbs)

### Main speaker (SP-DXJ21F)

Type:

3-Way 3-Speaker Bass-Reflex Type

(Magnetically Shielded Type)

Speakers:

Main Woofer: 16.0 cm (6-5/16 inches) cone  $\times$  1

Mid Range: 5.0 cm (2 inches) cone  $\times$  1

Tweeter: 2.0 cm (13/16 inches) dome  $\times$  1

Power Handling Capacity: 120 W

Impedance: 6  $\Omega$

Frequency Range: 45 Hz to 20 000 Hz

Sound Pressure Level: 87 dB/W•m

Dimensions (W  $\times$  H  $\times$  D):

205 mm  $\times$  370 mm  $\times$  236 mm

(8-1/8 inches  $\times$  14-5/8 inches  $\times$  9-5/16 inches)

Mass:

3.7 kg (8.2 lbs) each

### General

Power requirement: AC 120 V  $\sim$ , 60 Hz

Power consumption: 155 W

15 W (on standby)

Dimensions (W/H/D) (approx.):

185 mm x 370 mm x 372 mm

(7-5/16 inches x 14-5/8 inches x 14-11/16 inches)

Mass (approx.):

9.3 kg (20.6 lbs)

### Supplied Accessories

See page 3.

*Design and specifications are subject to change without notice.*

- Manufactured under license from Dolby Laboratories. "Dolby", and the double-D symbol are trademarks of Dolby Laboratories.
- "DTS" and "DTS 2.0+Digital Out" are registered trademarks of DTS, Inc.
- Microsoft and Windows Media are either registered trademarks or trademarks of Microsoft Corporation in the United States and/or other countries.
- This product incorporates copyright protection technology that is protected by U.S. patents and other intellectual property rights. Use of this copyright protection technology must be authorized by Macrovision, and is intended for home and other limited viewing uses only unless otherwise authorized by Macrovision. Reverse engineering or disassembly is prohibited.
- USE OF THIS PRODUCT IN ANY MANNER THAT COMPLIES WITH THE MPEG-4 VISUAL STANDARD IS PROHIBITED, EXCEPT FOR USE BY A CONSUMER ENGAGING IN PERSONAL AND NON-COMMERCIAL ACTIVITIES.

# Parts Index

## Remote control

Button	Page	Button	Page
⏻/I AUDIO	21 8, 36	KARAOKE SETTING +, -	8 33, 34
⏻/I TV	22 39	MIC MIX	6 31, 34
■	12 10, 12, 21, 28, 32	MENU/PL	27 11, 27
▶▶, ◀◀	33 9, 11, 12	ON SCREEN	28 24 – 26
▶▶, ◀◀	14 11, 21	NTSC/PAL	35 6
■	13 10, 19, 21	PREV., NEXT	14 12
↺	31 18	REPEAT	16 22, 28
^, v, >, <, ENTER/SET	8 6, 9, 11, 14 – 16, 18, 21, 24 – 28, 34, 35, 37	REPEAT A-B	16 22
Number buttons	1 8, 9, 11, 12, 20, 26, 34	RESERVE	7 34
3D PHONIC	18 15	RETURN	3 12
ACTIVE BASS EXT LEVEL +, -	37 13	REVERSE MODE	31 12, 29
ANGLE	15 18	SET UP	9 37
AUDIO/MPX	15 17	SHIFT	19 9, 11 – 13, 15, 16, 18, 19, 21, 22, 28, 31, 32, 34 – 36, 39
AUDIO VOL+,-	36 8, 9, 31	SLEEP	4 36
BALANCE L-R	17 13	SLOW ⊕, ⊖	33 19
CANCEL	5 21, 34, 36	SOUND MODE	17 14
CLOCK/TIMER	23 16, 35, 36	SUB TITLE	34 18
DIMMER	25 16	TAPE A ▶	29 8, 12
DISC 1-5	2 11	TAPE B ◀▶	30 8, 12
DISPLAY	28 16	TOP MENU/PG	7 11, 27
DVD/CD ▶	11 8, 10, 20, 21, 28, 32, 34	TV CH +, -	37 39
DVD LEVEL	20 15	TV VOL +, -	36 39
FADE MUTING	35 9	TV/VIDEO	24 39
FM/AM/AUX	32 8, 9	USB MEMORY ▶	10 8, 10, 28, 32
FM/PLAY MODE	13 9, 20, 21	VOCAL MASKING	9 32
GROUP/TITLE	14 11	VOCAL SUPP.	24 32
KARAOKE SCORING	27 32	VARIO BASS	20 13
KARAOKE SETTING	26 33, 34	VFP	35 15
		ZOOM	34 19, 28

## Main unit

Button	Page	Button	Page
⏻/I	2 8, 36	Disc trays	1 10
Display	3 7	DVD/CD ▶	5 8, 10, 28, 32, 34
■	30 10, 12, 21, 22, 28 – 30, 32	FM/AM/AUX	15 8, 9
▶▶, ◀◀	31 32 9, 11, 12, 19	KARAOKE SCORING	13 32
▶▶, ◀◀	28 29 11, 21	MIC 1, MIC 2	11 31 – 34
■	6 10, 19, 21	MIC LEVEL	10 31, 34
⏻ (USB memory terminal)	21 6, 10	PHONES	22 8
3D-PHONIC	27 15	PRESET +, -	28 29 9
ACTIVE BASS EX. +,-	16 17 13	PUSH OPEN▲	9 20 12, 29
DEMO	30 6	REVERSE MODE	26 12, 29
		REC START/STOP	23 30

Button	Page	Button	Page
DISC1-5 ▲	8 10, 22,	USB/DISC REC START	24 30
DISC1-5 ▷	19 11, 30		
DUBBING	25 30	USB MEMORY ▶	4 8, 10, 28, 30, 32
TAPE-A ▶	7 8, 12, 30		
TAPE-B ◀▶	18 8, 12, 29, 30	VARIO BASS	12 13
TUNING +,-	31 32 9	VOLUME	14 8, 9, 31

## Remote control

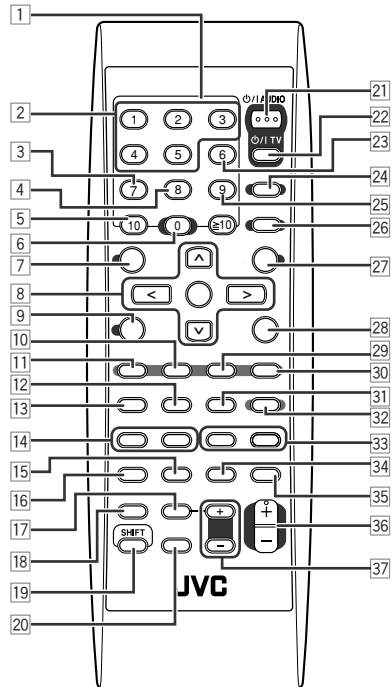

## Main unit

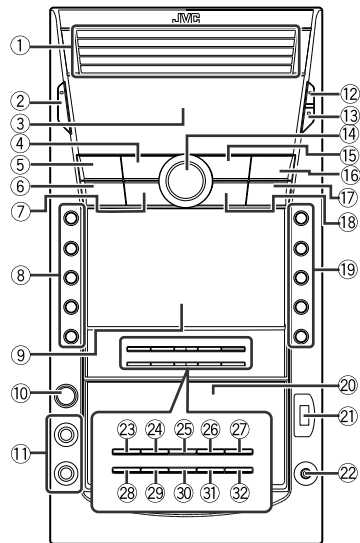

# ***TO OUR VALUED CUSTOMER*** —————

THANK YOU FOR PURCHASING THIS JVC PRODUCT.  
WE WANT TO HELP YOU ACHIEVE A PERFECT EXPERIENCE.

**NEED HELP ON HOW TO HOOK UP?  
NEED ASSISTANCE ON HOW TO OPERATE?  
NEED TO LOCATE A JVC SERVICE CENTER?  
LIKE TO PURCHASE ACCESSORIES?**

**JVC<sup>®</sup> IS HERE TO HELP!**  
**TOLL FREE: 1(800)252-5722**  
**<http://www.jvc.com>**

Remember to retain your Bill of Sale for Warranty Service.

————— **Do not attempt to service the product yourself** —————

**Caution**

To prevent electrical shock, do not open the cabinet.  
There are no user serviceable parts inside.  
Please refer to qualified service personnel for repairs.

---



# LIMITED WARRANTY

1-1 **USA ONLY**

**ONLY FOR PRODUCT PURCHASED IN U.S.A.**

JVC Americas Corp. (JVC) warrants this product and all parts thereof, except as set forth below **ONLY TO THE ORIGINAL RETAIL PURCHASER** to be **FREE FROM DEFECTIVE MATERIALS AND WORKMANSHIP** from the date of original purchase for the period shown below. ("The Warranty Period")

PARTS	<b>1 YR</b>	LABOR	<b>1 YR</b>
-------	-------------	-------	-------------

**THIS LIMITED WARRANTY IS VALID ONLY IN THE FIFTY (50) UNITED STATES, THE DISTRICT OF COLUMBIA AND IN THE COMMONWEALTH OF PUERTO RICO.**

**WHAT WE WILL DO:**

If this product is found to be defective within the warranty period, JVC will repair or replace defective parts with new or rebuilt equivalents at no charge to the original owner. Such repair and replacement services shall be rendered by JVC during normal business hours at JVC authorized service centers. Parts used for replacement are warranted only for the remainder of the Warranty Period. All products may be brought to a JVC authorized service center on a carry-in basis. Color televisions with a screen size of 37" class or greater qualify for in-home service. In such cases, a technician will come to your home and either repair the TV there or remove and return it if it cannot be repaired in your home.

**WHAT YOU MUST DO FOR WARRANTY SERVICE:**

*Please do not return your product to the retailer*

**Instead, return your product to the JVC authorized service center nearest you. If shipping the product to the service center, please be sure to package it carefully, preferably in the original packaging, and include a brief description of the problem(s). Please call 1-800-252-5722 to locate the nearest JVC authorized service center. Service locations can also be obtained from our website <http://www.jvc.com>. If your product qualifies for in-home service, the service representative will require clear access to the product.**

If you have any questions concerning your JVC Product, please contact our Customer Care Center at 800-252-5722

**WHAT IS NOT COVERED:**

This limited warranty provided by JVC does not cover:

1. Products which have been subject to abuse, accident, alteration, modification, tampering, negligence, misuse, faulty installation, lack of reasonable care, or if repaired or serviced by anyone other than a service facility authorized by JVC to render such service, or if affixed to any attachment not provided with the products, or if the model or serial number has been altered, tampered with, defaced or removed;
2. Initial installation, installation and removal from cabinets or mounting systems.
3. Operational adjustments covered in the Owner's Manual, normal maintenance, video and audio head cleaning;
4. Damage that occurs in shipment, due to act of God, and cosmetic damage;
5. Signal reception problems and failures due to line power surge;
6. User Removal Memory Devices/Video Pick-up Tubes/CCD Image Sensors are covered for 90 days from the date of purchase;
7. Accessories;
8. Batteries (except that Rechargeable Batteries are covered for 90 days from the date of purchase);
9. Products used for commercial purposes, including, but not limited to rental.
10. Loss of data resultant from malfunction of hard drive or other data storage device;

There are no express warranties except as listed above.

**THE DURATION OF ANY IMPLIED WARRANTIES, INCLUDING THE IMPLIED WARRANTY OF MERCHANTABILITY, IS LIMITED TO THE DURATION OF THE EXPRESS WARRANTY HEREIN.**

**JVC SHALL NOT BE LIABLE FOR ANY LOSS OF USE OF THE PRODUCT, INCONVENIENCE, OR ANY OTHER DAMAGES, WHETHER DIRECT, INCIDENTAL OR CONSEQUENTIAL (INCLUDING, WITHOUT LIMITATION, DAMAGE TO TAPES, RECORDS OR DISCS) RESULTING FROM THE USE OF THIS PRODUCT, OR ARISING OUT OF ANY BREACH OF THIS WARRANTY. ALL EXPRESS AND IMPLIED WARRANTIES, INCLUDING THE WARRANTIES OF MERCHANTABILITY AND FITNESS FOR PARTICULAR PURPOSE, ARE LIMITED TO THE WARRANTY PERIOD SET FORTH ABOVE.**

Some states do not allow the exclusion of incidental or consequential damages or limitations on how long an implied warranty lasts, so these limitations or exclusions may not apply to you. This warranty gives you specific legal rights and you may also have other rights which vary from state to state.

**JVC AMERICAS CORP.**

1700 Valley Road, Wayne, New Jersey 07470

<http://www.jvc.com>

**REFURBISHED PRODUCTS CARRY A SEPARATE WARRANTY, THIS WARRANTY DOES NOT APPLY. FOR DETAIL OF REFURBISHED PRODUCT WARRANTY, PLEASE REFER TO THE REFURBISHED PRODUCT WARRANTY INFORMATION PACKAGED WITH EACH REFURBISHED PRODUCT.**

**For customer use:**

Enter below the Model No. and Serial No. which is located either on the rear, bottom or side of the cabinet. Retain this information for future reference.

Model No. : \_\_\_\_\_

Serial No. : \_\_\_\_\_

Purchase date : \_\_\_\_\_

Name of dealer : \_\_\_\_\_

**JVC**

